



Servicios Industriales
DEL PACIFICO

2023 CATÁLOGO Carga



Garrucha Manual

Diseño compacto y liviano, perfecto para la construcción y contratistas donde la portabilidad y la facilidad de montaje son fundamentales

Baleros y bujes lubricados, piñones montados en baleros y mecanismo de engranajes rectos tratados térmicamente

Mecanismo de freno que bloquea el movimiento al tirar de lado la cadena de mando

Mecanismo de triple engranaje

Excelente y accesible opción para líneas de producción

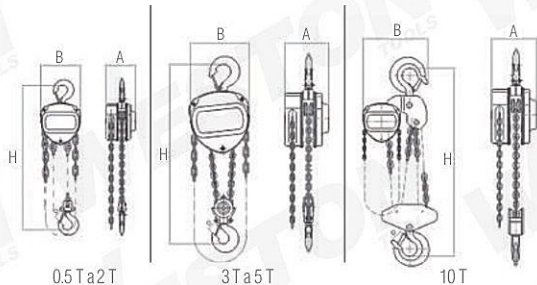

Capacidad marcada en gancho

Pestillo de seguridad para un aseguramiento correcto de la carga

Carcasa de acero delgado que soporta condiciones severas



Funcionamiento interno suave y eficiente con un esfuerzo mínimo



Ganchos de acero forjado giratorios de 360°



Presentación

Código	Capacidad	Elevación	Capacidad de quiebre	Esfuerzo requerido	No. de caídas de la cadena	ØCadena	Medidas (mm)				Peso
							A	B	H	D	
M-01070	0.5 T	3 m	0.75 T	200 N	1	6 mm	113	125	255	28	9 kg
M-01080	1 T	3 m	1.5 T	304 N	1	6 mm	126	147	306	32	11.5 kg
M-01090	1 T	4.5 m	1.5 T	304 N	1	6 mm	126	147	306	32	12.7 kg
M-01100	1 T	6 m	1.5 T	304 N	1	6 mm	126	147	306	32	13.9 kg
M-01110	1 T	10 m	1.5 T	304 N	1	6 mm	126	147	306	32	17 kg
M-01120	2 T	3 m	3 T	304 N	2	6 mm	141	183	368	36	16 kg
M-01130	2 T	4.5 m	3 T	304 N	2	6 mm	141	183	368	36	17.2 kg
M-01140	2 T	6 m	3 T	304 N	2	6 mm	141	183	368	36	18.4 kg
M-01150	2 T	10 m	3 T	304 N	2	6 mm	141	183	368	36	21.5 kg
M-01160	3 T	3 m	4.5 T	343 N	2	8 mm	141	183	486	46	27 kg
M-01170	3 T	4.5 m	4.5 T	343 N	2	8 mm	141	183	486	46	29.1 kg
M-01180	3 T	6 m	4.5 T	343 N	2	8 mm	141	183	486	46	31.1 kg
M-01190	3 T	10 m	4.5 T	343 N	2	8 mm	141	183	486	46	36.7 kg
M-01200	5 T	3 m	7.5 T	414 N	2	10 mm	163	215	616	46	43 kg
M-01210	5 T	4.5 m	7.5 T	414 N	2	10 mm	163	215	616	46	46.3 kg
M-01220	5 T	6 m	7.5 T	414 N	2	10 mm	163	215	616	46	49.6 kg
M-01225	5 T	10 m	7.5 T	414 N	2	10 mm	163	215	616	46	58.4 kg
M-01230	10 T	3 m	15 T	423 N	4	10 mm	163	404	750	75	75 kg
M-01240	10 T	4.5 m	15 T	423 N	4	10 mm	163	404	750	75	78.3 kg
M-01242	10 T	6 m	15 T	423 N	4	10 mm	163	404	750	75	81.6 kg
M-01244	10 T	10 m	15 T	423 N	4	10 mm	163	404	750	75	90.4 kg

Garrucha Cromada Manual

Fabricada en acero para mayor resistencia al impacto y durabilidad

Doble trinquete con doble guía de rodillos para un mejor desempeño, seguridad y confianza

Factor de seguridad 6:1

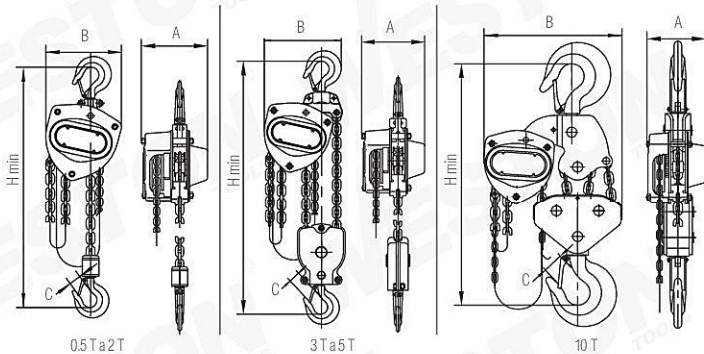

Capacidad marcada en gancho

Carcasa resistente al impacto, acabado cromado resistente a la corrosión

Pestillo de seguridad para un aseguramiento correcto de la carga



Funcionamiento interno que ofrece una operación fluida, sin esfuerzo y segura



Cadena de carga grado 80 con acabado negro anticorrosivo

Ganchos de acero forjado giratorios de 360°



Presentación

Código	Capacidad	Elevación	Capacidad de quiebre	Esfuerzo requerido	No. de caídas de la cadena	ØCadena	Medidas (mm)				Peso neto
							A	B	C	H	
M-01250	0.5 T	3 m	0.75 T	240 N	1	5 mm	132	148	28	345	11 kg
M-01260	0.5 T	6 m	0.75 T	240 N	1	5 mm	132	148	28	345	11 kg
M-01270	1 T	3 m	1.5 T	250 N	1	6 mm	151	172	32	376	12.5 kg
M-01280	1 T	6 m	1.5 T	250 N	1	6 mm	151	172	32	376	12.5 kg
M-01290	1 T	10 m	1.5 T	250 N	1	6 mm	151	172	32	376	12.5 kg
M-01300	2 T	3 m	3 T	335 N	1	8 mm	175	210	36	470	19.5 kg
M-01310	2 T	6 m	3 T	335 N	1	8 mm	175	210	36	470	19.5 kg
M-01320	2 T	10 m	3 T	335 N	1	8 mm	175	210	36	470	19.5 kg
M-01330	3 T	3 m	4.5 T	363 N	1	10 mm	176	230	46	565	29 kg
M-01340	3 T	6 m	4.5 T	363 N	1	10 mm	176	230	46	565	29 kg
M-01350	3 T	10 m	4.5 T	363 N	1	10 mm	176	230	46	565	29 kg
M-01360	5 T	3 m	7.5 T	360 N	2	9 mm	189	280	46	688	41.3 kg
M-01370	5 T	6 m	7.5 T	360 N	2	9 mm	189	280	46	688	41.3 kg
M-01380	5 T	10 m	7.5 T	360 N	2	9 mm	189	280	46	688	41.3 kg
M-01390	10 T	3 m	15 T	380 N	4	9 mm	189	463	57	765	78.5 kg
M-01400	10 T	6 m	15 T	380 N	4	9 mm	189	463	57	765	78.5 kg
M-01410	10 T	10 m	15 T	380 N	4	9 mm	189	463	57	765	78.5 kg

Garrucha Cromada Manual

Fabricado en acero para mayor resistencia al impacto y durabilidad

Doble trinquete con doble guía de rodillos para un mejor desempeño, seguridad y confianza

Elevación: 3 m

ØCadena: 9 mm

No. de caídas de la cadena: 4

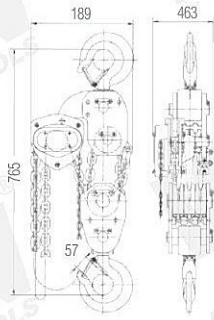

Medidas (mm)

Código	Capacidad	Capacidad de quiebre	Esfuerzo requerido	Peso
M-01390-R	10 T	15 T	380 N	78.5 kg

Polipasto Manual Mini 360°

Cubierta de la cadena de mando giratoria 360° permite elevación, tensión o colocación de cargas desde cualquier ángulo

Compacto, cuerpo de aluminio de peso ligero, fácil de transportar y resistente a la corrosión

Permite al usuario mantener una distancia segura al operar cargas muy pesadas, brindando seguridad y confianza

Gran desempeño y versatilidad

Elevación: 2.5 m

No. de caídas de la cadena: 1

Ideal para aplicaciones de arrastre donde la rotación de la cadena de mando requiera ser ajustada acorde a la operación

Usado en construcción, puertos, minería e incluso industrias farmacéutica o alimenticia

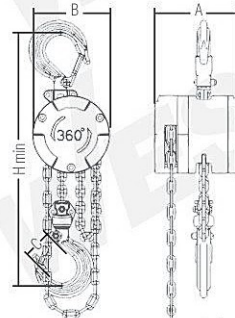

Código	Capacidad	Esfuerzo requerido	Espesor de eslabón (D)	Medidas (mm)					Peso neto	
				A	B	C	H min	E		
M-02540	0.25 T	147 N	Ø3.2 mm	89.5	84	25	240	9	8.4cm	2.5 kg
M-02545	0.5 T	187 N	Ø4.3 mm	103	102	30	270	12	10.2cm	4.5 kg

Garrucha de Palanca

Gran desempeño

Elevación: 1.5 m

Cuerpo de acero reforzado



Código	Capacidad	ØCadena
M-01420	0.75 T	6.3 mm
M-01440	1.5 T	7.1 mm
M-01460	3 T	9 mm

Garrucha Cromada con Palanca

Alto rendimiento

Elevación: 1.8 m

Acabado cromado resistente a la corrosión

Para operaciones severas

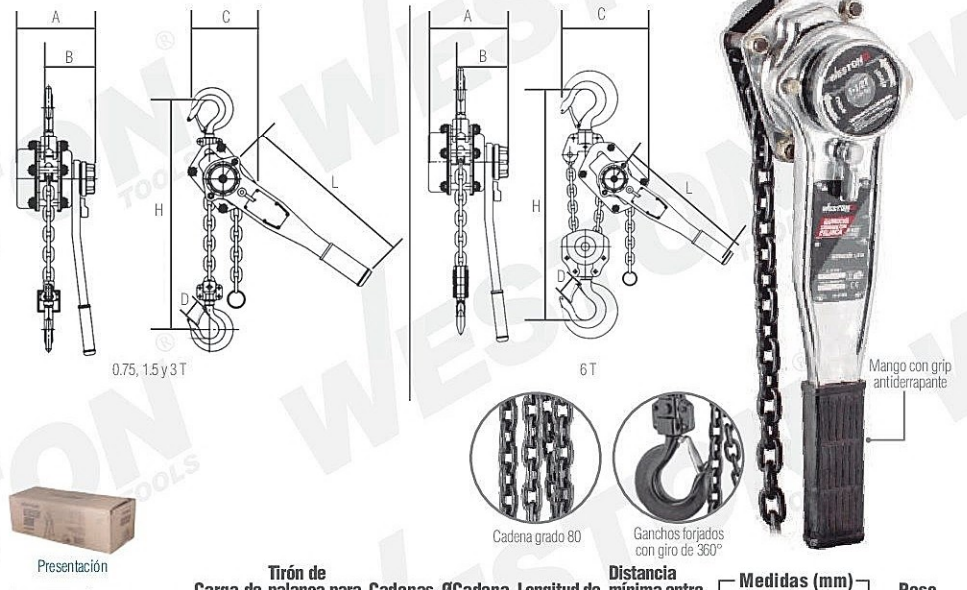

Código	Capacidad	Carga de prueba	Tirón de palanca para levantar	Cadenas de carga	ØCadena de carga	Longitud de palanca	Distancia mínima entre ganchos (H)	Medidas (mm)					Peso neto	
								A	B	C	D	L		
M-01430	3/4 T	1,125 kg	140 N	1	6 mm	278 mm	330 mm	148	88	135	32	290	320	7 kg
M-01450	1-1/2 T	2,250 kg	240 N	1	8 mm	378 mm	400 mm	176	102	155	36	415	380	11 kg
M-01470	3 T	4,500 kg	320 N	1	10 mm	418 mm	520 mm	195	109	211	41	415	480	19 kg
M-01490	6 T	7,500 kg	340 N	2	10 mm	418 mm	640 mm	195	109	254	46	415	600	32 kg



Mini Polipasto de Cadena

Voltaje: 120 V
 Frecuencia: 60 Hz
 Ciclo de trabajo: 2.5 min de uso por 7.5 de descanso
 Clase de protección IP54

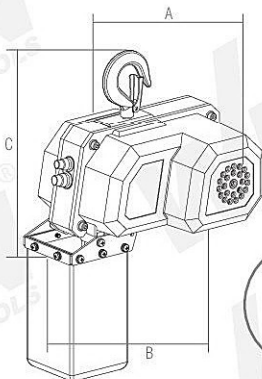

Presentación



Código	Capacidad	Elevación	Velocidad de elevación	Øcadena	Peso neto	Medidas (mm)		
						A	B	C
M-01062	150 kg	3 m	2.3 m/min	4 mm	7.9 kg	182	225	216
M-01064	300 kg	3 m	3 m/min	5 mm	14.3 kg	221	288	262
*M-01066	500 kg	3 m	2.8 m/min	6.3 mm	18.5 kg	176	382	300
M-01063	150 kg	6 m	2.3 m/min	4 mm	9 kg	182	225	216
M-01065	300 kg	6 m	3 m/min	5 mm	15.9 kg	221	288	262
M-01067	500 kg	6 m	2.8 m/min	6.3 mm	21 kg	176	382	300



Mini Polipasto Eléctrico

Frecuencia: 60 Hz
 Cable de acero
 Soporte de montaje incluido
 Limitador de altura
 Levantamiento: 6 m línea doble, 12 m línea sencilla



Bolsa para cadena

Control de elevación con interruptor de parada de emergencia

Gancho



Línea doble

Línea sencilla



Control con interruptor de parada de emergencia



Gancho forjado en acero



Refacciones para Mini Polipasto Eléctrico

Código	Descripción
M-01030-01	Carrete con cable y gancho para M-01030
M-01030-62	Capacitor PA400B para M-01030
M-01040-01	Carrete con cable y gancho para M-01040
M-01050-01	Carrete con cable y gancho para M-01050



Marco Giratorio con Capacidad de 300 kg
 * M-02090

Código	Capacidad línea sencilla/doble	Potencia	Tensión	Corriente	Øcable	Ciclo de trabajo
* M-01030	200/400 kg	850 W	120 V	7.1 A	3.8 mm	2.5 min de uso por 7.5 min de descanso
* M-01040	300/600 kg	1,180 W	120 V	9.85 A	4.5 mm	2 min de uso por 8 min de descanso
M-01050	500/1,000 kg	1,600 W	220 V	7.4 A	5.6 mm	2 min de uso por 8 min de descanso
M-01060	500/1,000 kg	1,500 W	120 V	13.2 A	5.6 mm	2.5 min de uso por 7.5 min de descanso

Polipasto Eléctrico de Cadena con Gancho Tipo Harrington

Motor trifásico
 Voltaje 220 V / 440 V
 Frecuencia 60 Hz
 Velocidad de rotación: 1,140 RPM

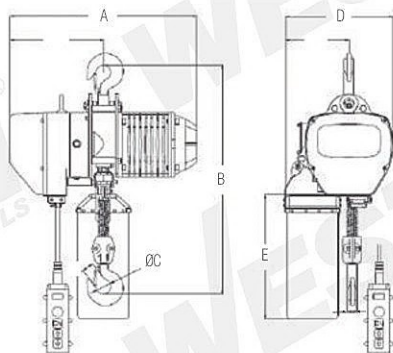

Ganchos con pestillo de seguridad para un aseguramiento correcto de la carga



Control de elevación con interruptor de parada de emergencia

Bolsa para cadena



Cadena grado 80

Código	Capacidad	Elevación	Velocidad de elevación	Número de cadenas	ØCadena	Potencia de motor	Medidas (mm)				
							A	B	ØC	D	E
M-02400	1 T	6 m	6.8 m/min	1	7.1 mm	2 Hp	520	650	42	300	350
M-02405	2 T	6 m	6.6 m/min	1	10 mm	4 Hp	615	800	49	430	350
M-02410	3 T	6 m	5.4 m/min	1	11.2 mm	4 Hp	615	845	59	430	350
M-02415	5 T	6 m	2.8 m/min	2	11.2 mm	4 Hp	615	1,030	60	430	350
M-02420	1 T	10 m	6.8 m/min	1	7.1 mm	2 Hp	520	650	42	300	350
M-02425	2 T	10 m	6.6 m/min	1	10 mm	4 Hp	615	800	50	430	350
M-02430	3 T	10 m	5.4 m/min	1	11.2 mm	4 Hp	615	845	59	430	350
M-02435	5 T	10 m	2.8 m/min	2	11.2 mm	4 Hp	615	1,030	60	430	350
M-02440	1 T	20 m	6.8 m/min	1	7.1 mm	2 Hp	520	650	42	300	350
M-02445	2 T	20 m	6.6 m/min	1	10 mm	4 Hp	615	800	50	430	350
M-02450	3 T	20 m	5.4 m/min	1	11.2 mm	4 Hp	615	845	59	430	350
M-02455	5 T	20 m	2.8 m/min	2	11.2 mm	4 Hp	615	1,030	60	430	350



Presentación



Cambio de corriente de 220V a 440V



Polipasto Eléctrico de Cadena con Trole Eléctrico Tipo Harrington

Motor trifásico
 Voltaje: 220 V/440 V
 Frecuencia: 60 Hz
 Velocidad de rotación (polipasto y trole): 1,440 RPM
 Velocidad de carrera (trole): 10/20 m/min



Ganchos con pestillo de seguridad para un aseguramiento correcto de la carga



Cambio de corriente de 220V a 440V

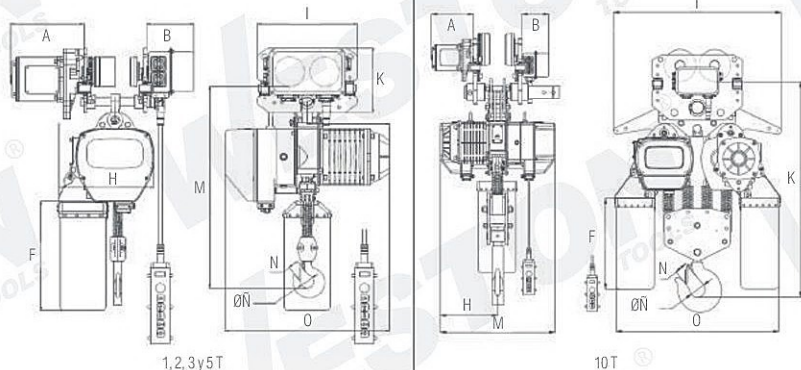

1,2,3y5T

10T



Bolsa para cadena
 Control de elevación con interruptor de parada de emergencia



Cadena grado 80



Presentación

Código	Capacidad	Elevación	Número de cadenas	ØCadena	Polipasto		Trole		Medidas (mm)									
					Velocidad de elevación	Potencia de motor	Potencia de motor	Apertura de eje	A	B	F	H	I	K	M	N	ØN	O
M-02500	1 T	6 m	1	7.1 mm	6.8 m/min	2 Hp	0.53 Hp	82 - 153 mm	231	142	350	300	315	210	650	32	42	520
M-02505	2 T	6 m	1	10 mm	6.6 m/min	4 Hp	0.53 Hp	100 - 153 mm	231	142	350	430	325	220	770	39	50	615
M-02510	3 T	6 m	1	11.2 mm	5.4 m/min	4 Hp	1 Hp	112 - 178 mm	231	142	350	430	340	250	830	45	59	615
M-02515	5 T	6 m	2	11.2 mm	2.8 m/min	4 Hp	1 Hp	125 - 178 mm	231	142	350	430	400	290	1,015	48	60	615
M-02517	10 T	6 m	4	11.2 mm	2.8 m/min	4 Hp	1 Hp	150 - 220 mm	231	142	500	315	922	1,190	631	70	85	897
M-02520	1 T	10 m	1	7.1 mm	6.8 m/min	2 Hp	0.53 Hp	82 - 153 mm	231	142	350	300	315	210	650	32	42	520
M-02525	2 T	10 m	1	10 mm	6.6 m/min	4 Hp	0.53 Hp	100 - 153 mm	231	142	350	430	325	220	770	39	50	615
M-02530	3 T	10 m	1	11.2 mm	5.4 m/min	4 Hp	1 Hp	112 - 178 mm	231	142	350	430	340	250	830	45	59	615
M-02535	5 T	10 m	2	11.2 mm	2.8 m/min	4 Hp	1 Hp	125 - 178 mm	231	142	350	430	400	290	1,015	48	60	615

Imán de Levantamiento Permanente

Fácil operación y manejo
 Fuerza magnética controlada al accionar la palanca manual
 Usado en fábricas, puertos, bodegas e industria del transporte
 Temperatura de uso: -40°C < 80°C
 Incluye llave allen para ajuste

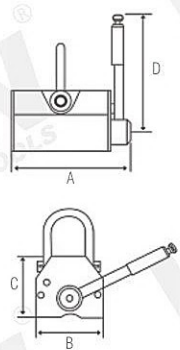

Grillete firme



Mecanismo de bloqueo en palanca



100 - 1,000 kg 2,000 - 5,000 kg
 Presentación

Código	Capacidad de levante plana	Capacidad de levante cilíndrica	Capacidad de quiebre	Medidas (mm)				Peso neto
				A	B	C	D	
M-02345	100 kg	30 kg	280 kg	92	62	72	160	3 kg
M-02350	200 kg	60 kg	500 kg	122	62	72	160	4 kg
M-02355	400 kg	120 kg	1,200 kg	182	92	95	205	11 kg
M-02360	600 kg	180 kg	1,800 kg	208	114	115	220	19 kg
M-02365	1,000 kg	300 kg	3,000 kg	266	134	140	250	34 kg
M-02370	2,000 kg	600 kg	6,000 kg	442	154	166	360	84 kg
M-02375	3,000 kg	900 kg	9,000 kg	532	170	190	490	124 kg
M-02380	5,000 kg	1,500 kg	15,000 kg	610	234	290	720	280 kg

Báscula Electrónica Colgante



Cuerpo y panel frontal de aluminio
 Función de apagado automático para ahorro de energía
 Incluye una báscula y accesorios

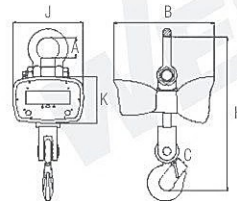

Grillete firme



Pantalla grande de 5 dígitos



Sensor de carga de alta precisión



Control remoto

Gancho con pestillo de seguridad para un aseguramiento correcto de la carga

Especificaciones Técnicas

Indicación de sobrecarga	100% F.S. + 9e
Rango cero	4% F.S.
Carga de seguridad	125% F.S.
Rango de tara	20% F.S.
Carga final	400% F.S.
Tiempo estable	≤10 s
Pantalla	LCD/LED de 30 mm de alto con 5 dígitos
Duración de la batería	≥70 horas
Adaptador	cc 9V / 1,000 mA
Humedad de operación	<85% RH por debajo de 20°C
Estándar	De acuerdo con OIML clase III
Tipo de batería	De plomo-ácido completamente sellada, 6 V/7 Ah
Distancia de control remoto	15 m mínimo
Batería del control	2 baterías tipo AAA de 1.5 V

Código	Capacidad	División mínima	Pesada máxima	Medidas (mm)					Peso neto	
				A	B	C	H	J		K
M-03150	1 T	0.5 kg	10 kg	80	340	30	420	230	155	12 kg



Trole Manual

Para montarse en vigas
Ideal para múltiples aplicaciones de manufactura y almacén
Facilita el transporte de equipos de levante al deslizarse en la viga

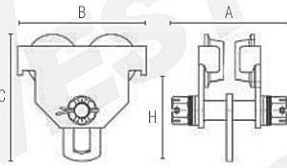

Código	Capacidad	Ancho de brida de viga	Medidas (mm)				Dimensiones generales	Peso
			A	B	C	H		
*M-01695	0.25 T	68 a 146 mm	220	196	186	118.5	235 x 85 x 165 mm	4.7 kg
M-01700	0.5 T	75 a 180 mm	251	204	188	113	280 x 75 x 143 mm	7 kg
M-01710	1 T	75 a 180 mm	262	250	214	118	285 x 80 x 180 mm	9 kg
M-01720	2 T	100 a 200 mm	293	270	227	125	325 x 105 x 210 mm	13 kg
M-01730	3 T	100 a 250 mm	318	315	304	165	370 x 115 x 235 mm	23 kg
M-01740	5 T	125 a 250 mm	380	358	334	183	420 x 140 x 285 mm	31 kg
M-01750	10 T	110 a 300 mm	503	430	434	250	500 x 280 x 350 mm	81 kg

* M-01695
Trole manual para portón

Trole Eléctrico

Eficiencia: 40%
Rueda de acero
Para transportar a largas distancias y/o cuando se usa con frecuencia
Apto para casi todos los polipastos con gancho
Ruedas fabricadas con acero



Código	Capacidad	Potencia	Velocidad
M-01820	3 T	0.4 kW	18 m/min

Abrazadera para Viga

Usada para colgar equipo de levante
Para trabajo pesado
Apertura ajustable para abrazar a la viga



Código	Capacidad	Rango
M-01760	1 T	75 - 230 mm
M-01770	2 T	75 - 230 mm
M-01780	3 T	80 - 345 mm
M-01790	5 T	80 - 345 mm

Pinza para Levantar Placas

Ojo con bisagra que permite que la garra coloque y levante la carga desde cualquier dirección
Cuerpo de acero de aleación, soldado para mayor resistencia
Ideal para el transporte vertical de placas
Con mordaza de acero

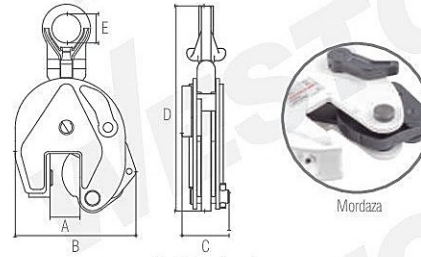

Código	Capacidad de levante	Capacidad de mordaza	Medidas (mm)					Peso neto
			A	B	C	D	E	
M-01670	1 T	0 - 20 mm	20	145	63	305	48	7 kg
M-01680	2 T	0 - 25 mm	25	175	68	375	60	8.5 kg
M-01690	3 T	0 - 30 mm	30	230	90	450	65	15 kg

Winch Eléctrico

Voltaje 12 V
Sistema de frenado automático
Con cable de acero y gancho
Embrague de giro libre
Engranaje de acero



M-00990



M-01000



M-01010



M-01020

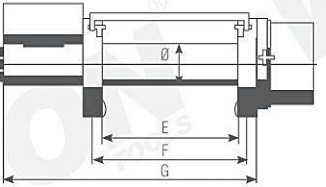
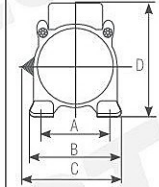
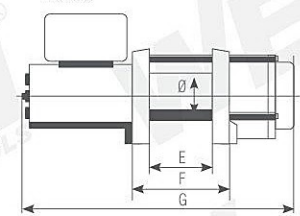
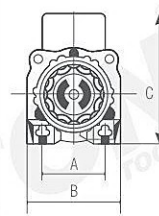
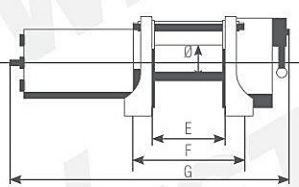
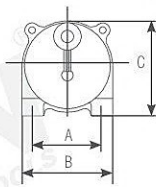

Código	Capacidad (lb)	Hp	Relación de engranaje	Ø cable	Largo de cable	Tipo de engranaje	Base de montaje	Medidas (mm)							Peso	
								A	B	C	D	Ø	E	F		G
M-00990	2,000 (907.18 kg)	0.95	253:1	4.8 mm (0.19")	7.6 m	Epicicloidial diferencial	123 x 76 mm	76	102	109	-	38	80	123	288	18 kg
M-01000	4,500 (2,041.2 kg)	2	145:1	6 mm (0.24")	12 m	Epicicloidial	123 x 76 mm	76	115	152	-	55	75	123	333	24 kg
M-01010	6,000 (2,721.6 kg)	2.6	294:1	6 mm (0.24")	28 m	3 etapas epicicloidiales	254 x 114 mm	114	156	180	193	63	228	254	550	23 kg
M-01020	9,000 (4,082.3 kg)	4.8	294:1	9.2 mm (0.36")	28 m	3 etapas epicicloidiales	254 x 114 mm	114	156	180	222	63	228	254	545	32.5 kg



Winch Eléctrico Portátil

Motor: 0.4 Hp (0.3 kW)
12V cc, máx. 40A
Vel. de línea: 6' (1.8 m/min) con carga
Cable de corriente: 15' (4.5 m)
Cable de control remoto: 9.9' (3 m)
Medidas: 240x254x190 mm
Peso: 13 kg
Incluye placa de montaje, manivela y cable galvanizado de Ø5.1 mm x 9 m



Código	Capacidad de enrollado	Capacidad marina	Capacidad de tracción
M-00980	6,000 lb (2,722 kg)	5,000 lb (2,268 kg)	2,000 lb (907 kg)

Winch Hidráulico

Se puede montar en camiones de rescate u otros vehículos
Rápida velocidad de línea proporciona una alta eficiencia para la recuperación
Motor hidráulico de alta resistencia
Freno mecánico integrado
Incluye cable galvanizado

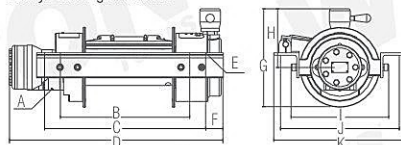

Código	Capacidad de tracción	ØCable	Largo de cable
M-01025	4 T (9,000 lb)	11 mm	25 m

Especificaciones Técnicas

Desplazamiento del motor	80 ml/rev
Flujo de aceite	15-60 L/min
Presión de aceite	2,000 PSI
Relación de engranaje	23:1
Base de montaje / tornillos	300x280 mm / 8 - M12
Dimensiones del tambor	Ø88 x Ø192 x 200 mm
Peso neto (con gancho y cable)	48 kg



Medidas (mm)										
A	B	C	D	E	F	G	H	I	J	K
G 1/2	300	385	516	8-Ø14	42.5	237	141	235	280	316

Winch Hidráulico

Motor hidráulico de larga duración y alta eficiencia, se puede girar para adaptarse a diferentes longitudes de tubería de aceite
Sistema de frenos hidráulicos multidisco 100% automático y confiable
Excelente relación peso-resistencia
Dos orificios de montaje de cable de acero en el tambor para una operación segura
Válvula de equilibrio doble garantiza una función de freno confiable
Sellado extremo brinda una resistencia al agua superior
Engranajes de acero endurecido de dos etapas de alta resistencia brindan un rendimiento y una eficiencia robustos
Cable no incluido

Especificaciones Técnicas

Flujo de aceite	75 L/min
Relación de engranaje	17:3:1
Capacidad para cable	Díámetro Ø14 mm (35,64") Largo 30 m (98,4')
Base de montaje	215.9 x 317.5 mm
Peso (sin cuerda de alambre)	76 kg
Clutch neumático	Rango de presión de aire: 1-8 bar (14.5-116 PSI) Volumen de ventilación: 1 L/min

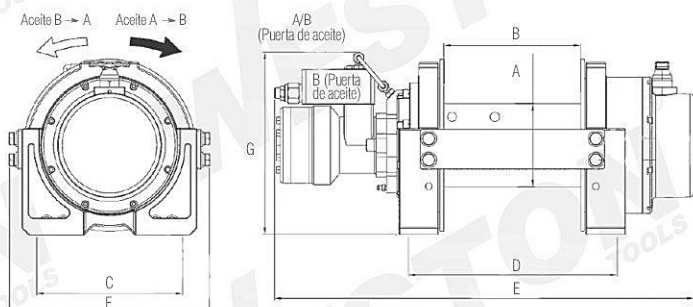

Código	Capacidad de tracción	Presión de trabajo	Dimensiones del tambor (Ax B)	Base de montaje (Cx D)	Dimensiones generales (Ex Fx G)
M-01027	8 T (8,172 kg)	17 MPa	126 x 208 mm	215.9 x 317.5 mm	637 x 304 x 276 mm



Entrada y salida de aceite



Clutch neumático

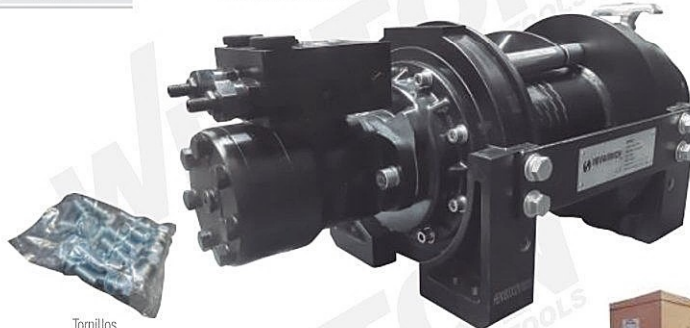

Tomillos



Presentación

Tirfor para Cable

Ligero y poderoso
Fácil de mover y utilizar
Permite resolver los numerosos problemas de tracción y elevación de una manera práctica y segura
Acabado esmaltado que lo hace resistente a la intemperie
Incluye cable de 20 m de largo y palanca

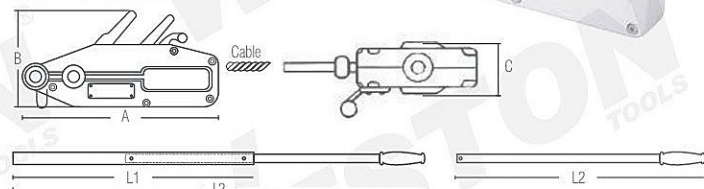

Código	Capacidad	Capacidad máxima en movimiento	Fuerza de trabajo	Øcable	Medidas (mm)					Peso neto
					A	B	C	L1	L2	
M-01840	800 kg	1,200 kg	341 N	8.3 mm	426	238	64	-	8,000	6.4 kg
M-01850	1,600 kg	2,400 kg	400 N	11 mm	545	284	97	6,920	12,000	12 kg
M-01860	3,200 kg	4,000 kg	438 N	16 mm	660	325	116	6,920	12,000	23 kg



Tirfor de Acero para Cable

Ligero y poderoso, fácil de mover y utilizar
Cuerpo de acero para mayor resistencia y durabilidad
Acabado esmaltado que lo hace resistente a la intemperie
Funciones: levante, arrastre y tensionamiento
Usado en: fábricas, minas, obras en construcción, ingeniería militar, construcción de vías férreas, de torres de energía, de presas e incluso en la industria forestal
Incluye cable de 20 m de largo y palanca



Código	Capacidad	Avance por palanqueo	Øcable	Medidas (mm)					Peso neto
				A	B	C	L1	L2	
M-01845	0.8 T	≥52 mm	8.3 mm	435	245	70	800	-	7 kg
M-01855	1.6 T	≥55 mm	11 mm	545	286	92	690	1,200	12 kg
M-01865	3.2 T	≥28 mm	16 mm	655	345	105	690	1,200	23 kg





Malacate Manual

Mango ergonómico antiderrapante para mayor comodidad

Botón de seguridad para liberar el mecanismo

Ideal para tensado de cables y mallas, para remolque de equipos pesado (M-01964 y M-01966)

Ideal para asegurar y rescatar vehículos, asistencia en traslado de animales, mudanzas y fletes (M-01968)



M-01966
Engrane de acero de una cremallera



M-01964
Engrane de acero de doble cremallera para mayor resistencia



Con cable



Ganchos forjados con pestillo de seguridad



M-01968
Engrane de acero de doble cremallera para mayor resistencia



Presentación

CON CABLE	Capacidad máx. de arrastre	Capacidad máx. de carga	Ø Cable	Longitud de cable	Longitud mínima	Longitud máxima
Código						
M-01964	1 T	500 kg	4.8 mm	3.65 m	1.9 m	3.45 m
M-01966	2 T	1,000 kg	4.8 mm	2.2 m	0.6 m	1.4 m

CON BANDA	Capacidad máx. de arrastre	Capacidad máx. de carga	Ancho de banda	Longitud de banda	Longitud mínima	Longitud máxima
Código						
M-01968	1 T	500 kg	25 mm	3.6 m	2 m	3.75 m

Malacate Manual con Cable

Para remolque de equipos pesado

Mango ergonómico antiderrapante para mayor comodidad

Botón de seguridad para liberar el mecanismo

Ideal para tensado de cables y mallas, remolques de equipos pesados



Engrane de acero de doble cremallera para mayor resistencia



Ganchos forjados con pestillo de seguridad

Código	Capacidad máx. de arrastre	Capacidad máx. de carga	Ø Cable	Longitud de cable	Longitud mínima	Longitud máxima
M-01970	1 T	500 kg	5 mm	3.5 m	0.5 m	1.5 m
M-01980	2 T	1,000 kg	4 mm	3.5 m	0.5 m	1.5 m

TAMBIÉN CONTAMOS CON:

ENGANCHES PARA REMOLQUE

Ver página 338



Restirador Manual con Cable

Cable de acero de 10 m de largo

Restirador con manivela

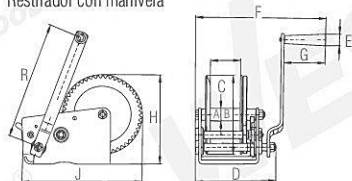

Código	Capacidad	Ø cable	Relación de engranaje	Medidas (mm)										
				A	B	C	D	E	F	G	H	J	R	
M-01900	600 lb (272.15 kg)	4 mm	2.9:1	21	116	51	119	25	228	91	138	165	180	
M-01910	800 lb (362.87 kg)	4 mm	3.7:1	21	116	51	119	25	228	91	138	165	180	
M-01920	1,200 lb (544.31 kg)	4 mm	4.2:1	21	135	51	119	25	228	91	156	184	180	
M-01930	2,000 lb (907.18 kg)	5 mm	10.35:14.5:1	27	150	65	174	25	281	91	182	250	251	

Restirador Manual con Cable y Gancho Uso Pesado

Cable de acero galvanizado

Largo máx. de palanca: 350 mm

Carga de presión colgante: 120

Ideal para utilizarse en ubicaciones de difícil acceso; el trinquete permite movimiento alternativo del mango en ambas direcciones para el alojamiento y descenso

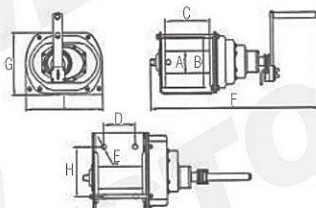

Gancho reforzado

Código	Capacidad	Ø x largo de cable	Medidas (mm)								Peso	
			A	B	C	D	E	F	G	H		I
● M-01940	1 T	Ø8 x 10m	Ø76	Ø175	154	110	Ø18	443	214	170	266	19.7 kg
M-01945	1 T	Ø8 x 40 m	Ø76	Ø175	154	110	Ø18	443	214	170	266	19.7 kg
● M-01950	2 T	Ø9 x 10 m	Ø90	Ø190	195	155	Ø18	490	230	170	300	25.1 kg
M-01955	2 T	Ø9 x 40 m	Ø90	Ø190	195	155	Ø18	490	230	170	300	25.1 kg

Cable de Acero Galvanizado con Gancho 7x19

Para tensión y soporte

Trenzado regular derecho (RHRL)



Código	Diámetro	Largo	Capacidad
B-462	3/16"	6.09 m	-
B-463	3/16"	7.60 m	-
B-464	3/16"	9.14 m	-
B-465	7/16"	20 m	2 T
B-470	7/16"	30 m	2 T
B-475	7/16"	40 m	2 T
B-480	5/8"	20 m	3 T
B-485	5/8"	30 m	3 T
B-490	5/8"	40 m	3 T

Tensor para Tracción de Cable

Fabricado en metal

Liviano y compacto

Mordaza dentada para evitar deslizamientos

Amplio ojo para usar con variedad de ganchos

Seguro rápido para cierre automático

Para usar con todo tipo de cables y cables de acero



Presentación

Código	Capacidad máxima	Diámetro de cable aplicable	Peso neto
M-01870	0.5 T	1 - 10 mm	0.4 kg
M-01880	1 T	2.5 - 16 mm	0.76 kg
M-01890	2 T	4 - 22 mm	1.35 kg

Tensor Forjado Tipo Cadena

Uso pesado
Fabricado en acero forjado
Para usar con cadena grado 70
Con tratamiento térmico que aumenta la resistencia

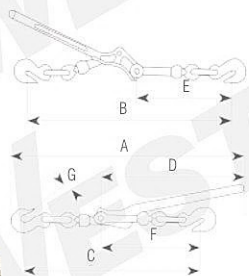

DISPONIBLE
Cadena Grado 70
VER PÁG. 257

Tensor Forjado Tipo Matraca

Uso pesado
Fabricado en acero forjado
Para usar con cadena grado 70
Con tratamiento térmico que aumenta la resistencia

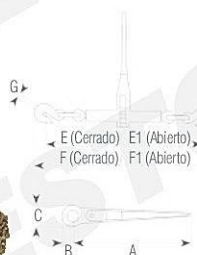

DISPONIBLE
Cadena Grado 70
VER PÁG. 257

Código	Medida	Capacidad	Capacidad de quiebre	Medidas (mm)							Peso
				A	B	C	D	E	F	G	
C-00400	1/4" - 5/16"	1,180 kg	4,173 kg	46	44	36	28.4	21.5	16	0.9	1.7 kg
C-00410	5/16" - 3/8"	2,460 kg	8,618 kg	61.3	56.2	45.4	40.6	26.3	26.3	1.2	3 kg
C-00420	3/8" - 1/2"	4,180 kg	14,968 kg	70.6	65.4	54	47.5	30.5	30.5	1.6	5.2 kg

Código	Medida	Capacidad	Capacidad de quiebre	Medidas (mm)							Peso
				A	B	C	E	E1	F	G	
C-00430	1/4" - 5/16"	1,180 kg	4,173 kg	18.2	2.2	4.5	44.2	56	48.8	0.9	1.7 kg
C-00440	5/16" - 3/8"	2,460 kg	8,618 kg	35.3	3.3	6.6	60.4	80.7	66.4	1.2	3 kg
C-00450	3/8" - 1/2"	4,180 kg	14,968 kg	33.3	3.3	6.6	60.5	80.8	73.5	1.6	5.2 kg

Cable de Acero con Alma de Fibra 6x19

Trenzado regular derecho (RHRL)



Código	Medida	Rollo
B-100	1/4"	500 m
B-105	5/16"	500 m
B-110	3/8"	500 m
B-115	1/2"	500 m
B-125	5/8"	500 m
B-130	3/4"	500 m
B-140	1"	500 m

Cable de Acero con Alma de Acero 6x19

Acero arado mejorado
Fuerza de tensión de 1,770 N/mm²
Alma de cable independiente (IWRC)
Trenzado regular derecho (RHRL)
CMR: Capacidad máxima de ruptura



Código	Medida	Largo	CMR	Peso neto (100 m/kg)
B-150	1/4"	500 m	2.7 T	17.3
B-155	5/16"	500 m	4.2 T	26.8
B-157	5/16"	1,000 m	4.2 T	26.8
B-160	3/8"	500 m	5.9 T	38.6
B-163	3/8"	1,000 m	5.9 T	38.6
B-164	7/16"	1,500 m	-	-
B-165	1/2"	500 m	10.4 T	68.4
B-167	1/2"	1,000 m	10.4 T	68.4
B-175	5/8"	500 m	16.2 T	107.1
B-180	3/4"	500 m	23.2 T	154.7
B-185	7/8"	500 m	31.4 T	211.2
B-190	1"	500 m	40.7 T	274.8

Cable de Acero con Alma de Fibra 6x26

Combina la resistencia a la flexión y a la abrasión
Fuerza de tensión de 1,770 N/mm²
Trenzado regular derecho (RHRL)
CMR: Capacidad máxima de ruptura



Código	Medida	Largo	CMR	Peso (100 m/kg)
B-201	1/4"	500 m	2.5 T	78
B-205	5/16"	500 m	3.9 T	122
B-210	3/8"	500 m	5.5 T	176
B-212	3/8"	1,000 m	5.5 T	352
B-215	1/2"	500 m	9.6 T	312.5
B-220	5/8"	500 m	15.2 T	491
B-222	5/8"	1,000 m	15.2 T	982
B-225	3/4"	500 m	21.4 T	706.5
B-227	3/4"	1,000 m	21.4 T	1,413
B-230	7/8"	500 m	29.3 T	959.25
B-235	1"	500 m	38 T	1,249.25
B-237	1"	1,000 m	38 T	2,498.5

Cable de Acero con Alma de Acero 6x26

Acero arado mejorado
Fuerza de tensión de 1,770 N/mm²
Alma de cable independiente (IWRC)
Trenzado regular derecho (RHRL)
CMR: Capacidad máxima de ruptura



Código	Medida	Largo	CMR	Peso neto (100 m/kg)
B-250	1/4"	500 m	2.7 T	17.3
B-255	5/16"	500 m	4.2 T	26.8
B-260	3/8"	500 m	5.9 T	38.6
B-265	7/16"	1,500 m	-	-
B-270	1/2"	500 m	10.4 T	68.4
B-275	5/8"	500 m	16.2 T	107.1
B-280	3/4"	500 m	23.2 T	154.7
B-285	7/8"	500 m	31.4 T	211.2
B-290	1"	500 m	40.7 T	274.8

Cable de Acero con Alma de Fibra 6x36

Fuerza de tensión de 1,770 N/mm²



Código	Medida	Largo	CMR
B-405	3/4"	500 m	21.23 T

Cable de Acero con Alma de Acero 6x36

Acero arado mejorado
Alma de cable independiente (IWRC)
Fuerza de tensión de 1,770 N/mm²
Trenzado regular derecho (RHRL)
CMR: Capacidad máxima de ruptura



Código	Medida	Largo	CMR	Peso neto
B-437	1/2"	500 m	10.4 T	68.4 kg
B-445	5/8"	500 m	16.2 T	107.1 kg
B-455	7/8"	500 m	31.4 T	211.2 kg

MANEJO DE MATERIALES - CARGA





Cable de Acero Galvanizado 7x7

Fabricado en acero con acabado galvanizado
Fuerza de tensión de 1,770 N/mm²
Para arrastre y carga de materiales
Trenzado regular derecho (RHRL)
CMR: Capacidad máxima de ruptura



Código	Medida	Largo	CMR	Peso neto (100 m/kg)
B-005	1/16"	100 m	0.22 T	1.11
B-005-1	1/16"	500 m	0.18 T	1
B-006	1/16"	1,500 m	0.22 T	16.65
B-010	3/32"	100 m	0.42 T	2.39
B-015	1/8"	100 m	0.77 T	4.26
B-015-1	1/8"	500 m	0.71 T	4
B-016	1/8"	1,500 m	0.77 T	63.9
B-018	3/16"	100 m	1.68 T	9.18
B-017-1	3/16"	500 m	1.61 T	8.9
B-017	3/16"	1,500 m	1.68 T	137.7
B-019-1	1/4"	100 m	3.18 T	15.74
B-018-1	1/4"	500 m	2.85 T	15.4
B-019	1/4"	1,500 m	3.18 T	236.1

Cable de Acero 7x7 con Recubrimiento de PVC

Fabricado en acero con acabado galvanizado
Para arrastre y carga de materiales
Fuerza de tensión de 1,770 N/mm²
Trenzado regular derecho (RHRL)
CMR: Capacidad máxima de ruptura



Código	Medida	Largo	CMR	Grosor de PVC	Peso neto (100 m/kg)
B-003	3/32"	100 m	0.42 T	1/32"	2.41
B-004	3/32"	500 m	0.42 T	1/32"	12.05
B-001	1/8"	100 m	0.77 T	1/16"	4.3
B-002	1/8"	500 m	0.77 T	1/16"	4.3

Cable de Acero Galvanizado 7x19

Fabricado en acero con acabado galvanizado
Fuerza de tensión de 1,770 N/mm²
Para arrastre y carga de materiales
Trenzado regular derecho (RHRL)
CMR: Capacidad máxima de ruptura



Cable de Acero 7x19 con Recubrimiento de PVC

Fabricado en acero con acabado galvanizado
Para arrastre y carga de materiales
Fuerza de tensión de 1,770 N/mm²
Trenzado regular derecho (RHRL)



Código	Medida	Largo
B-023	3/16" - 1/4"	100 m
B-024	3/16" - 1/4"	500 m

Cable de Acero con Alma de Acero 19x7

Acero arado mejorado
Alma de cable independiente (IWRC)
Fuerza de tensión de 1,770 N/mm²
Trenzado regular derecho (RHRL)
CMR: Capacidad máxima de ruptura



Código	Medida	Largo	Peso neto	CMR
B-530	3/8"	1,500 m	37.2 kg	5 T
B-540	1/2"	1,500 m	66.9 kg	8.8 T
B-560	5/8"	500 m	105.6 kg	13.8 T
B-550	3/4"	500 m	151.7 kg	19.8 T



Código	Medida	Largo	CMR	Capacidad de trabajo	Peso neto
B-019-2	3/32"	500 m	0.37 T	63 kg	11 kg
B-020	1/8"	100 m	0.91 T	152 kg	4.3 kg
B-020-1	1/8"	500 m	0.67 T	112 kg	19.5 kg
B-022	1/8"	1,500 m	0.91 T	152 kg	63.9 kg
B-026	3/16"	100 m	1.9 T	317 kg	9.8 kg
B-026-1	3/16"	500 m	1.51 T	252 kg	44 kg
B-027	3/16"	1,500 m	1.9 T	317 kg	147.6 kg
B-030	1/4"	100 m	3.18 T	530 kg	16.4 kg
B-030-1	1/4"	500 m	2.67 T	446 kg	78 kg
B-032	1/4"	1,500 m	3.18 T	530 kg	245.9 kg
B-035	5/16"	100 m	4.45 T	742 kg	25.9 kg
B-035-1	5/16"	500 m	4.12 T	687 kg	119 kg
B-038	5/16"	1,500 m	4.45 T	742 kg	43.5 kg
B-040	3/8"	100 m	6.55 T	1,092 kg	36.1 kg
B-040-1	3/8"	500 m	5.93 T	990 kg	172 kg
B-045	3/8"	1,500 m	6.55 T	1,092 kg	541.1 kg
B-045-1	7/16"	500 m	8.15 T	1,358 kg	235 kg
B-046	7/16"	1,500 m	7.78 T	1,297 kg	763.4 kg
B-050	1/2"	100 m	9.78 T	-	66.44 kg
B-047-1	1/2"	500 m	10.54 T	1,757 kg	307.5 kg
B-047	1/2"	1,500 m	9.78 T	1,630 kg	996.6 kg

TAMBIÉN CONTAMOS CON:



SUAJADORAS Y CORTACABLES

Ver página 330

Cadena de Acero Grado 30

Uso general
Eslabones electrosoldados con acabado uniforme que asegura la capacidad de carga
Gran resistencia a la corrosión
Cumple con la NACM90 y ASTM-A-413 (National Association of Chain Manufacturers)
Utilizada en granjas, industrias y el hogar
Ideal para delimitación de áreas, atado de cargas, aseguramiento de rejas y portones, carga y arrastre de objetos, amarre y remolque en ambientes corrosivos como el mar



Pulida

Galvanizada



NUEVO

HECHO EN MÉXICO

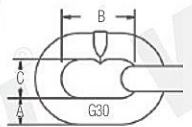

Largos y pesos aproximados

Pulida	Galvanizada	Grosor de eslabón (A)	Largo de cadena	Carga de trabajo	Resistencia de ruptura	Metro lineal/kg	Eslabón ojillo		Peso
						B C			
D-200	D-270	1/8"	131.38 m	125 kg	500 kg	0.28	16.05 mm	5.60 mm	25 kg
D-210	D-280	5/32"	84.14 m	180 kg	725 kg	0.32	22.85 mm	6.80 mm	25 kg
D-220	D-290	3/16"	62.31 m	360 kg	1,450 kg	0.43	24.85 mm	10.18 mm	25 kg
D-230	D-300	1/4"	63.77 m	590 kg	2,360 kg	0.82	31.40 mm	11.70 mm	50 kg
D-240	D-310	5/16"	37.04 m	860 kg	3,450 kg	1.33	33.00 mm	12.75 mm	50 kg
D-250	D-320	3/8"	24.39 m	1,200 kg	4,810 kg	1.98	36.80 mm	15.40 mm	50 kg
D-260	D-330	1/2"	12.99 m	2,040 kg	8,165 kg	3.60	39.60 mm	20.65 mm	50 kg
	D-350	5/8"	50 m	3,130 kg	12,519 kg	4.8	49.10 mm	22.60 mm	250 kg

Cadena de Acero Grado 70 con Ganchos

Fabricada en acero galvanizado con acabado tropicalizado
Con gancho en ambos extremos
Cadena para transporte; no recomendada para carga
Cumple con la NACM96 (National Association of Chain Manufacturers)

DISPONIBLES

Tensores Forjados
VER PÁG. 255

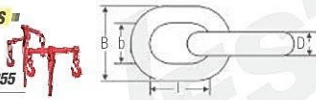

Código	Medida	Largo	Límite de carga (lb)		Medidas (mm)			
			Trabajo	Rotura	D	L	B	b
D-100	5/16"	16'	4,700	18,800	8.7	32.3	29.9	12.5
D-110	5/16"	20'	4,700	18,800	8.7	32.3	29.9	12.5
D-115	5/16"	25'	4,700	18,800	8.7	32.3	29.9	12.5
D-120	3/8"	16'	6,600	26,400	10.0	34.5	34.5	14.5
D-130	3/8"	20'	6,600	26,400	10.0	34.5	34.5	14.5
D-135	3/8"	25'	6,600	26,400	10.0	34.5	34.5	14.5
D-140	1/2"	20'	11,300	45,200	13	45.0	45.0	19.0

Cadena para Grúa con Gancho

Cadena 5/16" grado 70
Capacidad de carga 2 T
Pera de 5/8"
*Carga límite de trabajo: 2.11 T



C-02080 a C-02095

C-02100



Presentación



C-02105

C-02110

Código	Descripción	Largo de cadena	Ganchos	Con pera
*C-02080	2 Tramos de cadena "V"	8' (2.43 m)	J 15" (381 mm) en ambos extremos	Sí
*C-02085	2 Tramos de cadena "V"	6' (1.82 m)	J 15" (381 mm) en ambos extremos	Sí
*C-02090	2 Tramos de cadena "V"	3' (0.91 m)	J 15" (381 mm) en ambos extremos	Sí
*C-02095	2 Tramos de cadena "V"	8' (2.43 m)	J 8" (202 mm) en ambos extremos	Sí
C-02100	2 Tramos de cadena "V"	6' (1.82m)	RTJ en ambos extremos	Sí
C-02105	1 Tramo de cadena	6' (1.82m)	RTJ en un extremo y eslabón maestro de 7/16" en otro	Sí
C-02110	1 Tramo de cadena	6' (1.82m)	RTJ en un extremo y eslabón maestro de 7/16" en otro	No

Sujetador de Carga de Hule

Ganchos tipo "S" de acero pavonado en zinc resistente al óxido
Material de caucho EPDM de alta resistencia
Ideales para automóviles, botes y el hogar



Código	Medida	MIN	CAJA	MASTER
C-00732	14"	-	-	-
C-00734	19"	-	-	-
C-00736	24"	1	10	90
C-00738	45"	1	10	90



Eslinga de Cadena

Factor de seguridad 4:1
Cadenas grado 80
Eslabón maestro de 1-1/4"
Cadena disponible en 1/2" y 3/8"
Para manipular y soportar grandes cargas



De quijada con pestillo



De traba con asiento



Tensor Elástico con Ganchos de Acero

Ganchos de acero recubiertos con protector en las puntas
Cordón elástico para sujetar cargas
Ideal para automóviles, botes y el hogar



MIN: 1 / CAJA: 10 / MASTER: 50

Código	Medida	Largo
C-00740	8 mm	12"
C-00742	8 mm	18"
C-00744	8 mm	24"
C-00746	10 mm	36"
C-00748	10 mm	48"



Reducción de carga límite de trabajo

Temperatura de la eslinga	Reducción en carga límite de trabajo
-40 a 200 °C	Nula
200 a 300 °C	10%
300 a 400 °C	25%
A más de 400 °C	No usar

Código	No. de cadenas	Cadena		Carga límite de trabajo	Tipo de gancho	Carga de rotura	Capacidad de carga			
		Tamaño	Largo				2 cadenas (T)		4 cadenas (T)	
							45°	60°	45°	60°
C-02000	2	3/8"	6 m	5.5 T	De traba con asiento	22 T	4.25	3.15	-	-
C-02010	2	3/8"	6 m	5.5 T	De quijada con pestillo	22 T	4.25	3.15	-	-
C-02040	2	1/2"	6 m	9.4 T	De traba con asiento	37.6 T	7.5	5.3	-	-
C-02050	2	1/2"	6 m	9.4 T	De quijada con pestillo	37.6 T	7.5	5.3	-	-
C-02020	4	3/8"	6m	6.7 T	De traba con asiento	26.8 T	-	-	6.7	4.75
C-02025	4	3/8"	12m	6.7 T	De traba con asiento	26.8 T	-	-	6.7	4.75
C-02030	4	3/8"	6m	6.7 T	De quijada con pestillo	26.8 T	-	-	6.7	4.75
C-02035	4	3/8"	12m	6.7 T	De quijada con pestillo	26.8 T	-	-	6.7	4.75
C-02060	4	1/2"	6m	11.2 T	De traba con asiento	44.8 T	-	-	11.2	8
C-02065	4	1/2"	12m	11.2 T	De traba con asiento	44.8 T	-	-	11.2	8
C-02070	4	1/2"	6m	11.2 T	De quijada con pestillo	44.8 T	-	-	11.2	8
C-02075	4	1/2"	12m	11.2 T	De quijada con pestillo	44.8 T	-	-	11.2	8



**Eslinga Ojo y Ojo**

Factor de seguridad 6:1
Fabricada en poliéster
No daña la superficie de objetos
El color puede llegar a variar

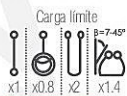

Código	Capacidad	Largo	Color
ME-1280	1.2 T	1.2 m	Morada
ME-1290	3 T	2.5 m	Amarilla
ME-1300	3.8 T	2.5 m	Amarilla
ME-1310	3.8 T	3.7 m	Amarilla

**Eslinga Plana Ojo a Ojo**

Factor de seguridad 7:1
No daña la superficie de objetos
Fabricada en poliéster, ojos reforzados con cubierta de piel
2 capas
Cumple con normas internacionales de seguridad:
JB/T8521.1-2007, EN1492-1:2000+A1:2008
Ideal para manejo de materiales

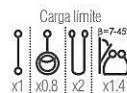

Código	Capacidad	Largo	Ancho	Color
ME-2000	2 T	2 m	2.3"	Verde
ME-2005	2 T	3 m	2.3"	Verde
ME-2010	2 T	4 m	2.3"	Verde
ME-2015	2 T	6 m	2.3"	Verde
ME-2020	3 T	2 m	3.5"	Amarillo
ME-2025	3 T	3 m	3.5"	Amarillo
ME-2030	3 T	4 m	3.5"	Amarillo
ME-2035	3 T	6 m	3.5"	Amarillo
ME-2040	3 T	8 m	3.5"	Amarillo
ME-2045	4 T	2 m	4.7"	Gris
ME-2050	4 T	3 m	4.7"	Gris
ME-2055	4 T	4 m	4.7"	Gris
ME-2060	4 T	6 m	4.7"	Gris
ME-2065	4 T	8 m	4.7"	Gris
ME-2070	4 T	10 m	4.7"	Gris
ME-2075	6 T	6 m	7"	Café
ME-2080	6 T	8 m	7"	Café
ME-2085	6 T	10 m	7"	Café
ME-2090	8 T	6 m	9.4"	Azul

**Eslinga Plana Ojo a Ojo**

Factor de seguridad 6:1
Fabricada en poliéster
ME-1100 a ME-1190: 2 capas
ME-1200 a ME-1226: 3 capas



Código	Capacidad	Largo	Ancho	Color
ME-1100	2 T	3 m	2"	Verde
ME-1101	2 T	2 m	2"	Verde
ME-1102	2 T	4 m	2"	Verde
ME-1103	2 T	6 m	2"	Verde
ME-1110	3 T	3 m	3"	Amarillo
ME-1111	3 T	2 m	3"	Amarillo
ME-1120	3 T	4 m	3"	Amarillo
ME-1130	3 T	6 m	3"	Amarillo
ME-1140	3 T	8 m	3"	Amarillo
ME-1145	4 T	2 m	4"	Gris
ME-1150	4 T	3 m	4"	Gris
ME-1160	4 T	4 m	4"	Gris
ME-1170	4 T	6 m	4"	Gris
ME-1180	4 T	8 m	4"	Gris
ME-1190	4 T	10 m	4"	Gris
ME-1200	6 T	6 m	4"	Gris
ME-1210	6 T	8 m	4"	Gris
ME-1220	6 T	10 m	4"	Gris

**Eslinga Círculo Sin Fin**

Factor de seguridad 6:1
Fabricada en poliéster
No daña la superficie de objetos
El color puede llegar a variar



Código	Capacidad	Largo	Color
ME-1230	2.4 T	1.2 m	Verde
ME-1240	2.4 T	1.8 m	Verde
ME-1250	3.8 T	1.8 m	Amarillo
ME-1260	3.8 T	2.4 m	Amarillo
ME-1270	3.8 T	3 m	Amarillo

**Sujetador de Carga con Matraca**

Factor de seguridad 3:1
Sistema de matraca para aplicar máxima tensión con mínimo esfuerzo
Mecanismo de rápida liberación
Banda fabricada en poliéster
Ganchos de acero
Para asegurar y evitar el movimiento de la carga



C-00721



C-00722



C-00715



C-00724



C-00726



C-00728

C-00720
Juego de 2 piezas

Código	Capacidad	Capacidad máxima	Ancho	Largo	Tipo de gancho	Uso	MIN	CAJA	MASTER
C-00720	225 kg	675 kg	1"	3 m	S	Ideal para autos y motos	1	3	12
C-00721	225 kg	675 kg	1"	3 m	S	Ideal para autos y motos	-	-	-
C-00722	750 kg	2,250 kg	1-1/2"	5 m	Doble S	Ideal para autos y motos	1	2	8
C-00715	1,650 kg	5,000 kg	2"	9 m	J	Ideal para tráileres y camiones	1	2	4
C-00724	1,650 kg	5,000 kg	2"	9 m	Plano	Ideal para tráileres y camiones	1	2	4
C-00726	1,800 kg	5,400 kg	3"	9 m	Plano	Ideal para tráileres y camiones	1	2	-
C-00728	2,000 kg	6,000 kg	4"	9 m	Plano	Ideal para tráileres y camiones	1	1	4

Banda con Gancho para Remolque

Malla de poliéster en 3 capas de 2"
Ganchos de acero ultra resistentes
Perfecta para remolcar vehículos pesados
Reforzada para una mayor resistencia



MIN: 1 / CAJA: 10

Código	Ancho	Largo	Capacidad de carga	Capacidad máxima
C-00757	2"	20'	1,515 kg	4,545 kg

Banda para Winch

Banda fabricada en poliéster
Gancho tipo plano



Código	Ancho	Largo	Capacidad de carga	Capacidad máxima
C-00755	4"	9.14 m	2,450 kg	7,348 kg

WESTON
Barra de Ajuste para Winch



Código	Medida
C-00750	35 mm x 84 cm

WESTON
Winch para Banda

Para montarse en transportes de carga y poder fijar las bandas



Código	Sujeción	Carga de trabajo	Para banda de
C-00760	Soldable	2 T	4"
C-00765	2 tornillos	2 T	4"

WESTON
Gancho con Perno para Cadena

Fabricado en acero al carbono forjado
Acabado galvanizado
Grado 43
Factor de seguridad 3:1

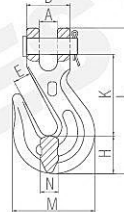

Código	Medida	Capacidad	Dimensiones (mm)									
			A±1	B±1.5	E±0.5	H±1	K±1	L±1	M±2	N±1	Peso	
C-00250	1/4"	2,600 lb	8.5	25	9.5	19	45	78.5	47.4	12.5	0.36 lb	
C-00255	5/16"	3,900 lb	11.5	29	11.5	25	54	96.5	54.5	16	0.62 lb	
C-00260	3/8"	5,400 lb	12.5	35	12.2	31	64.5	114.5	67.5	18	1 lb	
C-00265	1/2"	9,200 lb	18.5	47	17	39.5	85	148.5	91	20.5	2.22 lb	

WESTON
Gancho Forjado de Ojo sin Seguro

Acero forjado
Acabado galvanizado



Código	Medida	Capacidad
C-00273-01	1/4"	0.9 T
C-00274	1/2"	3 T

WESTON
Gancho con Perno para Cadena con Seguro

Acero forjado
Acabado galvanizado
Cuenta con pestillo para mantener la carga segura
Factor de seguridad 4:1

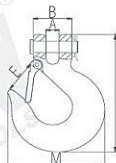

Código	Medida	Capacidad	Dimensiones (mm)						
			A±2	B±2	E±2	L±3	M±3		
C-00266	1/4"	1,950 lb	11	27	21.5	103	70.5		
C-00267	5/16"	2,875 lb	12.5	32	26	117	79		
C-00268	3/8"	4,000 lb	15	38	32	134	93.5		
C-00269	1/2"	6,500 lb	19	48	37.5	168	124.5		

WESTON
Gancho Forjado de Ojo con Seguro

Acero forjado
Acabado galvanizado
Cuenta con pestillo para mantener la carga segura
Factor de seguridad 4:1



Código	Medida	Capacidad	Dimensiones (mm)					
			A±2	B±2	E±2	L±3	M±3	
C-00270	1/4"	885 kg	8.5	13	21.5	103	70.5	
C-00271	5/16"	1,305 kg	9	16	26	117	79	
C-00272	3/8"	1,815 kg	10.25	18	32	134	93.5	
C-00273	1/2"	2,950 kg	14.5	23	37.5	168	124.5	

WESTON
Gancho de Acero Aleado de Ojo con Seguro

Acero aleado
Cuenta con pestillo para mantener la carga segura

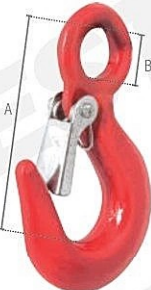

Código	Capacidad	A	B
C-00248-1R	3/4 T	2.8"	0.63"
C-00248-2R	1 T	3.22"	0.75"
C-00248-3R	1.5 T	3.66"	0.91"
C-00248-4R	2 T	4.09"	1.12"
C-00248-5R	3 T	4.69"	1.25"
C-00248-6R	4.5 T	5.78"	1.56"
C-00248-7R	7 T	7.38"	2.00"
C-00248-8R	11 T	9.06"	2.44"

WESTON
Gancho para Izaje con Espiga

Acero aleado
Cuenta con pestillo para mantener la carga segura

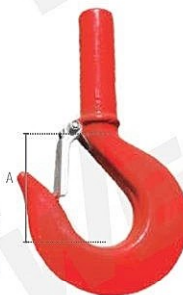

Código	Capacidad	A	Øzanco
C-00574	1 T	2.28"	0.59"
C-00576	1.5 T	2.53"	0.66"
C-00578	2 T	2.69"	0.72"
C-00580	3 T	3.06"	0.88"
C-00582	4.5 T	3.78"	1.16"
C-00584	7 T	4.75"	1.41"

WESTON
Gancho Giratorio de Acero Aleado (Alloy)

Cabeza giratoria
Acero aleado
Cuenta con pestillo para mantener la carga segura



Código	Capacidad	Color	A	B
C-00275	1 T	Amarillo	4.47"	1.25"
C-00275-1	1.5 T	Rojo	5.28"	1.50"
C-00276	2 T	Amarillo	6.02"	1.75"
C-00277	3 T	Amarillo	6.38"	1.75"
C-00278	4.5 T	Amarillo	7.41"	2"
C-00278-1	7 T	Rojo	9.59"	2.50"
C-00278-2	11 T	Rojo	11.13"	2.75"

WESTON
Gancho Giratorio de Acero al Carbono

Acero al carbón
Cabeza giratoria
Cuenta con pestillo para mantener la carga segura



Código	Capacidad	A	B
C-00586	3/4 T	4.47"	1.25"
C-00588	1 T	5.28"	1.50"
C-00590	1.5 T	6.02"	1.75"
C-00592	2 T	6.38"	1.75"
C-00594	3 T	7.41"	2"
C-00596	5 T	9.59"	2.50"
C-00598	7.5 T	11.13"	2.75"

WESTON
Gancho de Sujeción Soldable

Acero forjado
Acabado galvanizado
Factor de seguridad 4:1

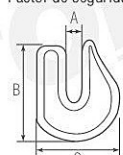

Código	Tamaño	Límite de carga	Medidas (mm)			Peso neto
			A	B	C	
C-00186	5/16"	2,132 kg	11.5	64	49.6	0.21 kg
C-00187	3/8"	2,994 kg	13	76	60	0.4 kg
C-00188	1/2"	5,126 kg	17.5	99	78.1	0.79 kg



WESTON
Gancho Clevis Trabacadena

Grado 80
Acabado rojo



Código	Medida	Capacidad
C-00513	1/4"	3,500 lb
C-00515	3/8"	7,100 lb
C-00520	1/2"	12,000 lb
C-00525	5/8"	18,100 lb
C-00530	3/4"	28,300 lb



Gancho Clevis con Seguro

Grado 80
Acabado rojo



Código	Medida	Capacidad (lb)
C-00500	8 mm	4,500
C-00505	10 mm	7,100
C-00510	13 mm	12,000

Gancho Clevis para Eslinga

Grado 80
Acabado rojo



Código	Medida	Capacidad (lb)
C-00535	3/8"	7,100
C-00540	1/2"	12,000
C-00545	5/8"	18,100
C-00550	3/4"	28,300

Pestillo de Seguridad para Gancho

Acero al carbón
Compatible con todos los ganchos que cuentan con pestillo



Código	Para gancho de	Medidas		
		A	B	C
C-00600-1	1/2 T	0.36"	0.51"	1.30"
C-00600-2	3/4 T	0.41"	0.59"	1.48"
C-00600-3	1 T	0.41"	0.67"	1.84"
C-00600-4	1.5 T	0.49"	0.75"	1.84"
C-00600-5	2 T	0.49"	0.87"	2.02"
C-00600-6	3 T	0.63"	1.00"	2.41"
C-00600-7	5 T	0.71"	1.42"	2.99"
C-00600-8	7.5 T	0.79"	1.57"	3.68"

Nudo para Cable Acero Inoxidable

Fabricado en acero inoxidable 304

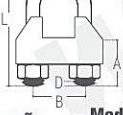

Código	Tamaño cable	Medidas (mm)					D (Paso)
		A	B	C	L		
C-00102	1/8"	14	11	22	20	3/16"	
C-00107	3/16"	16	13.5	26	24	1/4"	
C-00112	1/4"	20	17	32	31.5	5/16"	
C-00117	5/16"	22	18.3	35	34	5/16"	
C-00122	3/8"	27	22.5	40	41.8	3/8"	
C-00127	1/2"	35	27	49	53.9	7/16"	
C-00136	3/4"	42	34.5	61	68.7	9/16"	

Nudo Forjado para Cable

Nudo galvanizado en su totalidad para resistir la oxidación y corrosión
Cuenta con base forjada
Con rosca rolada

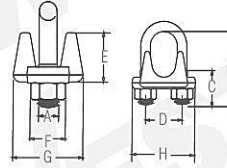

Código	Tamaño cable	Peso por 100 (lb)	Medidas (pulgadas)							
			A	B	C	D	E	F	G	H
C-00148	3/16"	10	0.25	0.97	0.56	0.59	0.50	0.44	0.94	1.18
C-00150	1/4"	19	0.31	1.03	0.50	0.75	0.66	0.56	1.19	1.43
C-00155	5/16"	28	0.38	1.38	0.75	0.88	0.73	0.69	1.31	1.66
C-00160	3/8"	48	0.44	1.50	0.75	1	0.91	0.75	1.63	1.94
C-00165	1/2"	80	0.50	1.88	1	1.19	1.13	0.88	1.91	2.28
C-00170	5/8"	110	0.56	2.25	1.25	1.31	1.34	0.94	2.06	2.50
C-00175	3/4"	142	0.62	2.75	1.44	1.50	1.39	1.06	2.25	2.84
C-00180	7/8"	212	0.75	3.12	1.62	1.75	1.58	1.25	2.44	3.16
C-00185	1"	252	0.75	3.50	1.81	1.88	1.77	1.25	2.63	3.47



Nudo para Cable Maleable

Fabricado en hierro maleable
Resistente a la corrosión
Acabado galvanizado



Código	Tamaño cable	Carga límite de trabajo
C-00050	1/16"	0.05 T
C-00100	1/8"	0.13 T
C-00105	3/16"	0.31 T
C-00110	1/4"	0.49 T
C-00115	5/16"	0.55 T
C-00120	3/8"	0.7 T
C-00125	1/2"	1.14 T
C-00130	5/8"	2.02 T
C-00135	3/4"	2.52 T
C-00140	7/8"	3.49 T
C-00145	1"	4.61 T

Eslabón de Unión

Grado 80

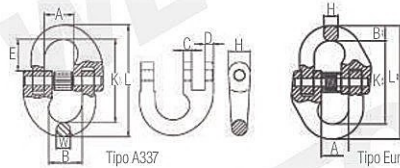

Código	Medida	Tipo	Carga límite de trabajo	Carga de rotura	Dimensiones (mm)								Peso neto	
					A	B	L	K	W	H	C	D		E
C-00686	5/16"	A337	2 T	8 T	17.7	21.8	78.5	58.5	9.8	14.5	6.5	6.6	21.5	0.15 kg
C-00687	3/8"	A337	3.2 T	12.8 T	22	24	87.6	63.6	12	17	6.2	8.1	21.5	0.33 kg
C-00689	1/2"	A337	5.4 T	21.6 T	28.5	35	115.5	85.5	15	21.6	7.8	7.8	28	0.76 kg
C-00691	5/8"	A337	8.2 T	32.8 T	33	40.5	143	106	18.5	26	9.5	10	36	1.3 kg
C-00693	3/4"	A337	12.8 T	51.2 T	41	47	162	116	23	32	12	13	39	2.27 kg
C-00694	7/8"	A337	15.5 T	62 T	50.5	54.5	188.5	136.5	26	38	13	15.5	47.5	3.4 kg
C-00697	6 mm	Euro	1.12 T	4.48 T	15	7.5	58	42	-	7	-	-	-	0.08 kg
C-00698	7 mm	Euro	1.5 T	6 T	20	8.5	73	54.8	-	8.5	-	-	-	0.145 kg
C-00699	7-8 mm	Euro	2 T	8 T	20.5	9.5	79.5	60.5	-	8.5	-	-	-	0.146 kg
C-00695	1"	Euro	21.2 T	84.8 T	57.5	31	220	158	-	30	-	-	-	4.5 kg
C-00696	1-1/4"	Euro	32.7 T	126 T	67.5	38	281	205	-	37	-	-	-	9.24 kg



Eslabón Maestro A-342

Grado 80
Acabado rojo



Código	Medida	Capacidad
C-00560	1/2"	3.2 T
C-00562	5/8"	4.1 T
C-00564	3/4"	5.6 T
C-00566	1"	11 T
C-00568	1-1/4"	16.4 T
C-00570	1-1/2"	24.6 T
C-00572	2"	46.5 T

Ensamble de Eslabón Maestro

Material aleación A345



Código	Medida
C-00971	3/4"
C-00972	1"
C-00973	1-1/4"
C-00974	1-1/2"

Casquillo Tope de Aluminio Sencillo

Aluminio
Usado para cable de acero
Tipo sencillo



DISPONIBLES: Suajadores para Casquillos VER PÁG. 330

Código	Medida
C-01100	1/16"
C-01102	3/32
C-01104	1/8"
C-01106	3/16"
C-01108	1/4"

Casquillo Tope de Aluminio Doble

Aluminio
Tipo doble
Usado para cable de acero

Código	Medida
C-01065	1/16"
C-01070	3/32"
C-01075	1/8"
C-01080	3/16"
C-01085	1/4"
C-01090	5/16"
C-01092	3/8"



DISPONIBLES: Suajadores para Casquillos VER PAG. 330

Casquillo Tope de Acero Sencillo

Acero
Tipo sencillo
Usado para cable de acero

Código	Medida
C-01655	3/16"
C-01685	9/16"
C-01695	3/4"



Casquillo de Presión de Acero S505

Forjado

Código	Medida
C-01500	1/4"
C-01510	5/16"
C-01520	3/8"
C-01530	7/16"
C-01540	1/2"
C-01550	5/8"
C-01560	3/4"
C-01570	7/8"
C-01580	1"
C-01590	1-1/8"
C-01600	1-1/4"
C-01610	1-3/8"
C-01620	1-1/2"



Cuello Galvanizado G411

Acero galvanizado
Recomendado para aplicaciones y condiciones de cargas livianas

Código	Medida
C-00190	1/8"
C-00191	3/16"
C-00192	1/4"
C-00193	5/16"
C-00194	3/8"
C-00195	1/2"
C-00195-05	5/8"
C-00195-00	3/4"



Cuello Galvanizado G414

Acero galvanizado
Vida útil más larga

Código	Medida
C-00196-00	3/8"
C-00196-01	1/2"
C-00196	5/8"
C-00197	3/4"
C-00197-00	7/8"
C-00197-01	1"



Terminal de Vaciado G416 Abierta con Ranura

Acabado galvanizado

Código	Medida de cable
C-01700	5/16"-3/8"
C-01710	7/16" - 1/2"
C-01730	3/4"
C-01740	7/8"
C-01750	1"



Terminal de Vaciado G417 Cerrada con Ranura

Acabado galvanizado

Código	Medida de cable
C-01760	5/16"-3/8"
C-01770	7/16"-1/2"
C-01780	9/16" - 5/8"
C-01790	3/4"
C-01800	7/8"
C-01810	1"



Grillete para Cable

Perno con rosca
Forjados - templados y revenidos, con pernos de aleación
Para utilizar en aplicaciones de fijación, remolque, suspensión o aplicaciones de izaje

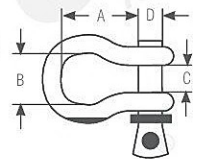

Código	Tamaño	Carga límite de trabajo	Medidas (pulgada)			
			A	B	C	D
C-00200	1/4"	0.5 T	1.13	0.78	0.47	0.31
C-00205	5/16"	0.75 T	1.22	0.84	0.53	0.38
C-00210	3/8"	1 T	1.44	1.03	0.66	0.44
C-00215	1/2"	2 T	1.88	1.31	0.81	0.63
C-00220	5/8"	3.25 T	2.38	1.69	1.06	0.75
C-00225	3/4"	4.25 T	2.81	2	1.25	0.88
C-00226	7/8"	6.5 T	3.19	2.27	1.44	1
C-00230	1"	8.5 T	3.75	2.69	1.69	1.13
C-00235	1-1/8"	9.5 T	4.25	2.91	1.81	1.25
C-00240	1-1/4"	12 T	4.69	3.25	2.03	1.38
C-00243	1-3/8"	13.5 T	5.25	3.63	2.25	1.5
C-00245	1-1/2"	17 T	5.75	3.88	2.38	1.63
C-00247	1-3/4"	25 T	7	5	2.88	2



Grillete para Cable de Acero Inoxidable

Perno con rosca
Acero inoxidable 304
Para utilizar en aplicaciones de fijación, remolque, suspensión o aplicaciones de izaje

Código	Medida	Capacidad
C-00198	1/8"	50 lb
C-00199	5/32"	150 lb
C-00200-1	3/16"	300 lb
C-00202	1/4"	450 lb
C-00207	5/16"	650 lb
C-00212	3/8"	1,000 lb
C-00217	1/2"	1,990 lb
C-00224	3/4"	4,475 lb



Tuerca de Ojo Hembra

Galvanizada por inmersión en caliente
Acero forjado - templado revenido
Recomendada para carga en línea
Con rosca estándar UNC

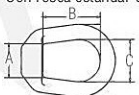

Código	Grosor armella	Ø Máx. de rosca	Carga límite de trabajo	Medidas		
				A	B	C
C-00673	5/16"	3/8"	1,250 lb	1"	1.2"	0.83"
C-00675	3/8"	1/2"	2,250 lb	1.25"	1.44"	1.08"
C-00677	1/2"	5/8"	3,600 lb	1.5"	1.92"	1.35"
C-00679	5/8"	3/4"	5,200 lb	1.75"	2.38"	1.59"
C-00681	3/4"	7/8"	7,200 lb	2"	2.63"	1.96"
C-00683	7/8"	1"	10,000 lb	2.25"	3.06"	2.21"
C-00685	1"	1-1/4"	15,500 lb	2.5"	3.5"	2.46"



Eslabón de Horquilla Doble

Cuerpo de acero al carbón, forjado y con tratamiento térmico
Pasadores de acero aleado, templado y revenido
La carga de rotura es 4 veces la carga límite de trabajo

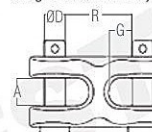

Código	Medida	Carga límite de trabajo	Carga de rotura	Dimensiones			
				A	D	G	R
C-00249	1/4-5/16"	4,700 lbs	18,800 lbs	0.47"	0.38"	0.43"	1.18"
C-00249-1	3/8"	6,600 lbs	26,400 lbs	0.53"	0.47"	0.48"	1.34"
C-00249-2	7/16-1/2"	11,250 lbs	45,000 lbs	0.65"	0.56"	0.63"	1.75"



MANEJO DE MATERIALES - CARGA



Armella de Acero Forjado Larga

Acero forjado templado
Tornillo galvanizado en caliente después de roscar (UNC)
Cumple con ASME B30.26



Tuerca hexagonal galvanizada en caliente

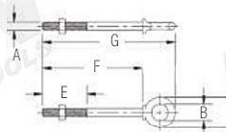

Código	Medida (Grosor tornillo x Largo tornillo)	Ø interno (B)	Carga límite de trabajo	Medidas			Peso por 100 lbs
				A	E	F	G
C-02130	1/4" x 2"	0.5"	650 lbs	0.25"	1.5"	2"	2.94"
C-02133	5/16" x 2-1/4"	0.62"	1,200 lbs	0.31"	1.5"	2.25"	3.5"
C-02136	3/8" x 2-1/2"	0.75"	1,550 lbs	0.38"	1.5"	2.5"	3.97"
C-02139	1/2" x 3-1/4"	1"	2,600 lbs	0.5"	1.5"	3.25"	5.12"
C-02142	5/8" x 4"	1.25"	5,200 lbs	0.62"	2"	4"	6.44"
C-02145	3/4" x 4-1/2"	1.5"	7,200 lbs	0.75"	2"	4.5"	7.44"
C-02148	1" x 6"	2"	13,300 lbs	1"	3"	6"	9.97"

Tornillo Ojo Forjado

Acero forjado
Factor 5:1

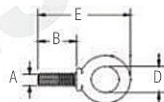

Bolsa resellable

Código	Rosca (A)	Largo a tensar	Capacidad de carga	Medidas (mm)		
				B	E	D
C-00600	1/4"-20	1"	0.29 T	25.9	58	19.1
C-00605	5/16"-18	1-1/8"	0.54 T	29.2	69.5	22.4
C-00610	3/8"-16	1-1/4"	0.70 T	32.3	78	25.4
C-00615	1/2"-13	1-1/2"	1.18 T	38.9	94	30.2
C-00620	5/8"-11	1-3/4"	2.36 T	45.5	113	35.1
C-00625	3/4"-10	2"	3.27 T	52	129	38.1
C-00630	7/8"-9	2-1/4"	4.80 T	58.5	149	44.5
C-00635	1"-8	2-1/2"	6.00 T	65.5	169	52
C-00640	M8 x 1.25	13 mm	0.54 T	13	54.6	22.4
C-00645	M10 x 1.5	17 mm	0.70 T	17	64.3	25.4
C-00650	M12 x 1.75	20.5 mm	1.20 T	20.5	77.7	30.2
C-00655	M16 x 2.0	27 mm	2.40 T	27	96	35.1
C-00660	M20 x 2.5	30 mm	3.30 T	30	108	38.1
C-00665	M22 x 2.5	33 mm	4.80 T	-	-	-
C-00670	M24 x 3.0	36 mm	6.00 T	36	142	51

Tensor Ojo a Gancho

Uso pesado
Acero forjado
Acabado galvanizado



Código	Medida	Largo a tensar	Capacidad de carga (lb)
C-00305	3/8"	6"	1,000
C-00310	1/2"	6"	1,500
C-00315	1/2"	12"	1,500
C-00320	5/8"	6"	2,250
C-00325	5/8"	12"	2,250
C-00330	3/4"	6"	3,000
C-00335	3/4"	12"	3,000
C-00337	3/4"	18"	3,000
C-00340	7/8"	6"	4,000
C-00343	7/8"	12"	4,000
C-00345	1"	6"	5,000
C-00350	1"	12"	5,000

Tensor Horquilla a Horquilla

Acero galvanizado
El cuerpo tiene roscas UNC
Cumple con norma ASME B30.26

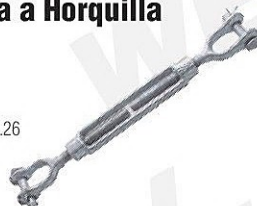

Código	Medida	Largo a tensar	Capacidad de carga (lb)
C-00314	1/2"	6"	2,200
C-00316	1/2"	9"	2,200
C-00317	1/2"	12"	2,200
C-00324	5/8"	6"	3,500
C-00329	5/8"	12"	3,500
C-00332	3/4"	6"	5,200
C-00336-1	3/4"	12"	5,200
C-00347	1"	6"	10,000
C-00352	1"	12"	10,000
C-00353	1-1/4"	12"	15,200
C-00354	1-1/4"	18"	15,200
C-00355	1-1/4"	24"	15,200
C-00357	1-1/2"	24"	21,400
C-00358	1-1/2"	12"	21,400

Tensor Ojo a Ojo

Uso pesado
Acero forjado
Acabado galvanizado



Código	Medida	Largo a tensar	Capacidad de carga (lb)
C-00312	1/2"	6"	2,200
C-00322	5/8"	6"	3,500
C-00327	5/8"	12"	3,500
C-00336	3/4"	12"	5,200

Tensor Ojo a Gancho de Zinc

Fabricado en zinc



Código	Medida	Largo a tensar
C-00280	5/32"	3-11/32"
C-00285	3/16"	3-3/4"
C-00290	1/4"	5-1/4"
C-00295	5/16"	6-3/16"
C-00300	3/8"	7"

Garrucha de Zinc Fija

Sencilla y doble
Fabricada en zinc
Remaches de acero
De uso ligero
Para uso en norias, tendedores



Sencillo



Doble

Código	Tipo	Medida	Límite de carga	Carga de rotura	Ø ojo
C-00800	Sencillo	1"	25 kg	100 kg	6 mm
C-00805	Sencillo	1-1/2"	50 kg	200 kg	10 mm
C-00810	Sencillo	2"	50 kg	200 kg	12 mm
C-00815	Doble	1"	25 kg	100 kg	6 mm
C-00820	Doble	1-1/2"	50 kg	200 kg	10 mm

Garrucha de Zinc Giratoria

Sencillo y doble
Fabricada en zinc
Remaches de acero
De uso ligero
Para uso en norias, tendedores



Sencillo



Doble

Código	Tipo	Medida	Límite de carga	Carga de rotura	Ø ojo
C-00823	Sencillo	3/4"	25 kg	100 kg	10 mm
C-00825	Sencillo	1"	25 kg	100 kg	10 mm
C-00830	Sencillo	1-1/2"	50 kg	200 kg	20 mm
C-00835	Sencillo	2"	50 kg	200 kg	20 mm
C-00840	Doble	1"	25 kg	100 kg	10 mm
C-00845	Doble	1-1/2"	50 kg	200 kg	20 mm
C-00850	Doble	2"	50 kg	200 kg	20 mm

Pasteca Giratoria

Fabricada en acero al carbón
Uso ligero
*Pasteca doble



Pestillo de seguridad



Gancho

Grillete

Código	Tipo	Medida	Capacidad	Para cable de
C-01900	Gancho	3"	2 T	3/8"
C-01905	Gancho	4.5"	4 T	1/2"
C-01910	Gancho	6"	8 T	3/4"
C-01915	Gancho	8"	8 T	3/4"
C-01920	Grillete	3"	2 T	3/8"
C-01925	Grillete	4.5"	4 T	1/2"
*C-01950	Gancho	4.5"	4 T	1/2"

Garrucha para Cable

Cuerpo robusto
Garrucha de hierro fundido
Gancho forjado en forma de gota con pestillo de seguridad



Código	Medida	Cable	Capacidad
C-00852	6"	5/8"	2 T
C-00853	8"	3/4"	4 T

Polea Garrucha para Cable

Cuerpo robusto
Gancho de acero

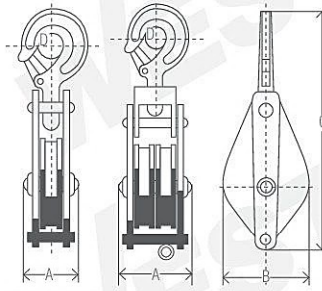

Sencilla

Doble



Código	Tipo	Medida	Capacidad	Dimensiones (mm)				Ø cable (mm)		
				A	B	C	D	Idóneo	Máximo	Peso
C-00854	Sencilla	4-1/2"	1 T	70.5	116	310	37.5	7.7	11	4.4 kg
C-00854-1	Sencilla	6"	2 T	88	152	405	45	11	14	7.98 kg
C-00854-2	Sencilla	8"	5 T	117	212	570	60	15.5	18.5	23.79 kg
C-00854-3	Doble	4"	1 T	80	98	335	37.5	6.2	7.7	3.3 kg
C-00854-4	Doble	4-1/2"	2 T	94.5	116	420	45	7.7	11	6.5 kg
C-00854-5	Doble	6"	3 T	116	152	525	50	11	14	11 kg

Pasteca Giratoria Uso Rudo

Factor de seguridad 5:1
Fabricada en acero

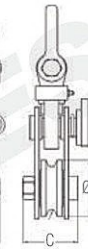
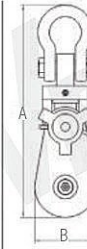
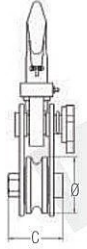
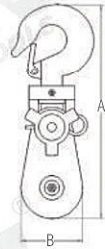

Gancho

Grillete

Código	Tipo	Medida	Capacidad	Para cable de	Dimensiones (mm)				Peso
					A	B	C	β	
C-00853-3	Gancho	3"	2 T	3/8"	292	82	70	75	3.9 kg
C-00853-4	Gancho	4-1/2"	4 T	1/2"	358	120	70	115	6.2 kg
C-00853-5	Gancho	6"	6 T	3/4"	498	160	93	150	14.1 kg
C-00853-6	Gancho	8"	8 T	3/4"	549	210	93	200	19 kg
C-00853-03	Grillete	3"	2 T	3/8"	286	82	70	75	3.9 kg
C-00853-04	Grillete	4-1/2"	4 T	1/2"	345	120	70	115	6.2 kg
C-00853-05	Grillete	6"	6 T	3/4"	475	160	93	150	14.1 kg
C-00853-06	Grillete	8"	8 T	3/4"	528	210	93	200	18.7 kg

Exhibidor Mini para Garruchas

Material: PTR calibre 14 de 1-1/2" x 1-1/2"
Argollas de alambroñ soldadas de 2-1/2"
Placa: espesor 3/16", medida 10 x 8 cm
4 rodajas de poliuretano con polipropileno giratorias con freno (Y-4093-77)
Acabado: pintura esmaltada en color negro mate
Medidas: 115 x 118 x 60cm
Exhibidor para uso exclusivo de garruchas marca Weston Tools®



Placa

Placa

Código	Descripción
EX-CARGAMINI	Paquete de garruchas con exhibidor para punto de venta. Pregunte a tu asesor de ventas.

Exhibidor Mediano de Herramienta de Carga

Material: PTR de 2" x 2"
Medidas: 110 x 200 cm
Incluye rótulo de la marca Weston Tools® de 110 x 20 cm y 12 argollas de alambroñ Ø2-1/2" interior
Bases de lámina de acero de 40 x 50 cm
Acabado: pintura en color negro mate electrostático
Exhibidor para uso exclusivo de productos marca Weston Tools®



Código	Descripción
EX-CARGAMED	Paquete de herramienta de carga con exhibidor para punto de venta. Pregunte a tu asesor de ventas.

**TAMBIÉN
CONTAMOS CON:**

**GRUA PLEGABLE
PARA MOTOR**



Ver página 341



Soga de Polipropileno

La resistencia a la tensión aplica para sogas nuevas y sin nudos
Variación en el rendimiento de +/- 5%
Resistente a la abrasión
Color amarillo/azul
100% polipropileno
Incluye carrete
No se pudre
Uso industrial, agrícola y comercial



3/16" (completamente amarillo)



Presentación

MxC: Metros por carrete

Código	Diámetro	Rendimiento (m/kg)	Resistencia a tensión (kg)	MxC
B-600	3/16"	110+/-11	145.6 kg	1,100
B-610	1/4"	52.6+/-5.2	304 kg	1,052
B-620	5/16"	34+/-3.4	464 kg	680
B-630	3/8"	24+/-1.9	672 kg	480
B-640	7/16"	19	832 kg	380
B-650	1/2"	13+/-1	1,200 kg	338
B-660	5/8"	8.3+/-0.4	1,920 kg	215.8
B-670	3/4"	6.3+/-0.3	2,528 kg	163.8
B-680	1"	4	4,224 kg	104

Soga de Polipropileno

La resistencia a la tensión aplica para sogas nuevas y sin nudos
Variación en el rendimiento de +/- 5%
Resistente a la abrasión
Color gris/verde (puede variar)
v90% polipropileno, 10% polietileno
Incluye carrete
No se pudre
Uso agrícola y comercial



3/16" (completamente gris)



Presentación

MxC: Metros por carrete

Código	Diámetro	Rendimiento (m/kg)	Resistencia a tensión (kg)	MxC
B-690	3/16"	110+/-11	116.8 kg	1,100
B-700	1/4"	52.6+/-5.2	243.2 kg	1,052
B-710	5/16"	34+/-3.4	371.2 kg	680
B-720	3/8"	24+/-1.9	537.6 kg	480
B-730	1/2"	13+/-1	960 kg	338
B-740	5/8"	8.3+/-0.66	1,535 kg	215.8



HECHO EN MÉXICO

Rafia Comercial

100% polipropileno
Calibre 2.2 g/m
Uso general
Alta resistencia a la tensión
Ideal para: embalaje, delimitar espacios, paquetería, agricultura, jardinería, trabajos manuales



Presentación

Código	Color	Largo	Peso por rollo
B-776	Blanco	410 m	900 g
B-777	Negro	410 m	900 g

Patín para Mover Carga

Usado para trasladar cualquier objeto pesado
Rodillo de poliuretano para asegurar la facilidad de movimiento y distribuir la carga protegiendo del daño causado por grandes cargas y contaminación de grasa
Asas en ambos extremos para facilitar el movimiento
Ruedas de poliuretano
La carga se puede levantar utilizando una barra para mover carga o el gato, permitiendo que los patines puedan colocarse fácilmente debajo del objeto



Tipo A Base giratoria



Tipo B

DISPONIBLE

Barra para mover carga M-02180 VER PÁG. 264

Código	Tipo	Capacidad	Ruedas	Medidas (Largo x Ancho x Alto)	Peso
M-02110	A	6 T	4	280x215x110 mm	13.5 kg
M-02115	A	8 T	6	380x215x110 mm	20 kg
M-02130	A	12 T	8	475x220x110 mm	27.5 kg
M-02100	B	6 T	4	280x215x110 mm	13.5 kg
M-02120	B	12 T	8	475x220x110 mm	27.5 kg



Patín para Mover Carga con Rotación

Ligero
Fácil de operar
Rotación de 180°
Para cargas pesadas
Tamaño de rueda: Ø80x70 mm



M-02160

M-02170

Código	Capacidad	Superficie	Ruedas
M-02160	6 T	22x28 cm	4
M-02170	8 T	18x31 cm	6

Juego de Patines para Mover Carga

Formado por módulo frontal (X) y módulo trasero (Y)
X: dolly frontal con mango
Y: 2 dollies traseros en línea recta con barra conectora
Tamaño de rueda: Ø80x70 mm



M-02150

M-02140

Código	Capacidad	Llantas por módulo
M-02140	4 T	4
M-02150	8 T	8



Barra para Mover Carga

Herramienta auxiliar para los patines para mover carga M-02110, M-02115, M-02130, M-02100, M-02120
Para uso de carga general



Rueda



Con rodillos de acero

COMPATIBLE CON: Patines para mover carga VER PÁG. 264

Código	Capacidad	Largo de palanca	Peso
M-02180	5 T	1,520 mm	10 kg



Apilador Manual para Tarima

Mástil de acero de alta calidad garantiza rigidez y durabilidad
Cuenta con cuchillas ajustables
Ideal para espacios estrechos



Ruedas de nailon



Rejilla de seguridad

Especificaciones Técnicas

Velocidad de levante con carga	20 m/s
Velocidad de levante sin carga	22 m/s
Velocidad de descenso con carga	143 m/s
Velocidad de descenso sin carga	53 m/s
Radio de giro	1,190 mm
Medidas (Largo x Ancho x Alto)	130 x 145 x 209 cm
Peso	336 kg

WESTON

Patín Eléctrico para Tarima

Ideal para utilizarse en almacenes muy amplios y en grandes supermercados para transporte de mercancía de media distancia
BDI y horómetro
Ruedas para equilibrar la estabilidad
Motor CA sin carbones
Rueda motriz vertical
Cambio de batería lateral
Plataforma con sensor de velocidad
Incluye batería industrial y cargador externo



Timón ergonómico



Botón de paro de emergencia

Especificaciones Técnicas

Distancia del centro de carga	600 mm (C)
Altura mínima del tenedor	82 mm (H13)
Tamaño de rueda frontal	Ø 250x70 mm
Tamaño de rueda trasera	Ø 82x126 (98) mm
Ruedas adicionales	Ø 127x57 mm
Ruedas, número frontal y trasero (x=ruedas motrices)	1x+2(2/4)
Máxima altura de elevación	202 mm (H3)
Longitud de cara al tenedor	610 mm (L1)
Dimensiones del tenedor	53x180x1,100 (1,220) (S/E/L)
Anchura total de tenedores	685 mm (B5)
Velocidad de desplazamiento con/sin carga	7/7.1 km/h
Tensión de la batería	24/210V/Ah
Capacidad nominal K5	
Peso de batería	196 kg
Dimensiones de batería	750x170x634 mm

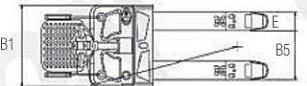
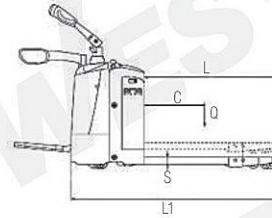

Código	Capacidad	Elevación	Centro de carga	Largo de horquillas
Y-9099-API	1 T	1.6 m	50 cm	1,060 mm

Código	Capacidad (Q)	Voltaje	Anchura total (B1)	Peso total en servicio (con batería)
Y-9100	2 T	110 V 1 PH	775 mm	720 kg

Patín Hidráulico para Tarima

Ideal para el manejo de mercancía en almacenes, tales como carga, descarga y traslado de una zona a otra, etc.
Construcción de acero de calibre pesado
Control manual de 3 posiciones: elevar, bajar y neutral
Altura máxima (h3): 190 mm
Altura mínima (h13): 75 mm
Diámetro de rodillo: Ø74 x 93 mm
Palanca de ruido (dB): <70



REFACCIONES DISPONIBLES

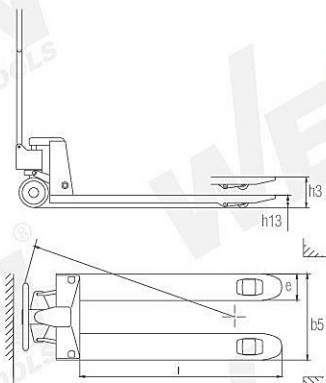

Código	Capacidad	Longitud tenedor (l)	Ancho tenedor (e)	Ancho total de tenedor (b5)	Ruedas	Diámetro de rueda	Peso neto (kg)	Radio de giro
Y-9099-PAT	2.5 T (2,500 kg)	1,220 mm	160 mm	685 mm	Poliuretano	180 mm	70.5	1,335 mm
Y-9099-PATN	2.5 T (2,500 kg)	1,220 mm	160 mm	685 mm	Nailon	180 mm	65.5	1,335 mm
Y-9099-PATG	2.5 T (2,500 kg)	1,220 mm	160 mm	685 mm	Poliuretano	180 mm	72	1,335 mm
Y-9099-PAS	2 T (2,000 kg)	1,100 mm	150 mm	520 mm	Poliuretano	160 mm	53	1,265 mm

WESTON

Refacciones para Patín Hidráulico para Tarima

WESTON



Código	Descripción
Y-9099-100	Bomba y pistón
Y-9099-110	Palanca
Y-9099-ADV	Asiento de válvula
Y-9099-ARN	Arandela 49x15
Y-9099-ARV	Árbol de válvula
Y-9099-CAD	Cadena
Y-9099-DIN	Palanca de descenso inferior
Y-9099-PAL	Palanca de descenso superior
Y-9099-PEC	Perno con hoyo 12x60
Y-9099-PPG	Perno de rueda grande 25x170
Y-9099-PPM	Perno de maneral 20x106
Y-9099-RE2	Sello hidráulico 31.5x41.5x6
Y-9099-RE3	Sello hidráulico 18x26x5
Y-9099-RE4	Limpiador 18x26x4.5
Y-9099-RES	Resorte helicoidal 0.5x48x21
Y-9099-RET	Limpiador 31.5x39.5x5
Y-9099-RNG	Anillo tipo "O"
Y-9099-RPN	Pasador de rodillo 16x40
Y-9099-RS2	Resorte 5.5x48x93
Y-9099-TDM	Tubo de maneral
Y-9099-TDS	Tuerca de seguridad M5
Y-9099-VAR	Varilla

MANEJO DE MATERIALES - CARGA

**Carretilla para Tambor**

Abrazadera con forma "C" que sujeta firmemente el tambor
 Aseguramiento por medio de cadena y palanca con ajuste de matraca
 Eleva, transporta, gira, inclina y drena tambores completamente cargados

Para utilizarse con tambor de acero o tambor de plástico

Bloqueable en posición horizontal o vertical

Inclinación de 360°

Peso neto: 42kg / Peso bruto: 45 kg

**Diablo Profesional**

Rueda de hule de 7"
 Solera 3/16"x1" y 1/4"x1-1/2"
 Tubo de 3/4"
 Redondo 3/4"

**Diablo Reforzado**

Rueda de hule de 8"
 Solera 3/16"x1" y 1/4"x1-1/2"
 Tubo de 3/4"
 Redondo 3/4"

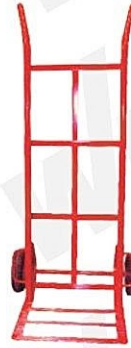

Código	Capacidad	Tamaño de tambor	Diámetro	Altura
Y-9098-500	365 kg	55 gal (210L)	22-1/2"	36"

Código	Descripción	Capacidad	Dimensiones
Y-9098-200	Profesional	200 kg	118x39x30 cm

Código	Descripción	Capacidad	Dimensiones
Y-9098-400	Reforzado	400 kg	137x47x30 cm

**TAMBIÉN
CONTAMOS CON:**



EQUIPO DE SEGURIDAD Y SEÑALIZACIÓN

Ver sección de **Seguridad**

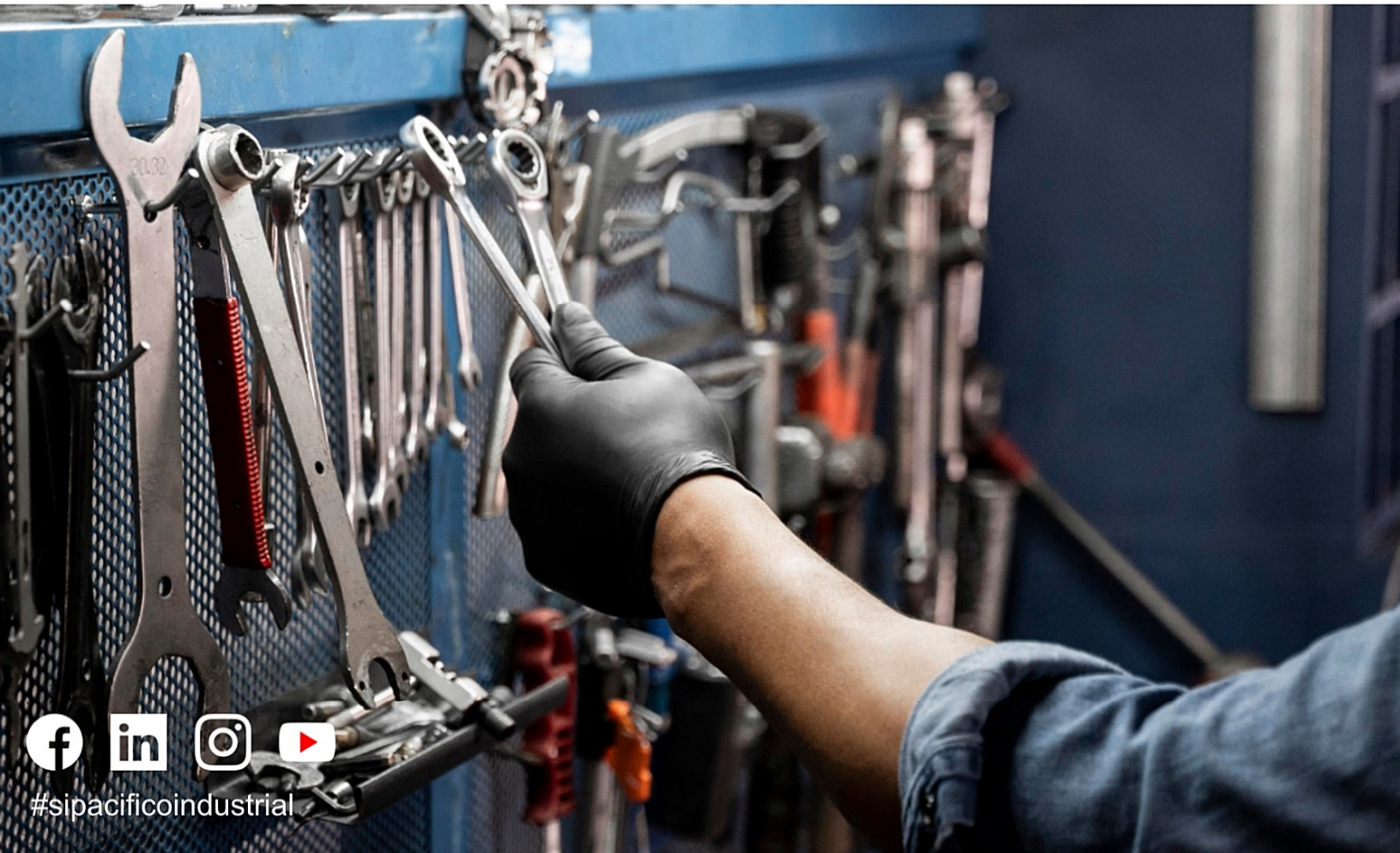

#sipacificoindustrial



Servicios Industriales DEL PACIFICO

ALIADO ESTRATEGICO DE LA INDUSTRIA

Teléfono: +52 (663) 107 7832

Correo: contacto@sipacifico.com.mx

Dirección
Ciruelo s/n, Col. Granja Santa Cecilia C.P 21386
Mexicali Baja California